



# 2015 MY OBD System Operation

## Summary for Diesel Engines

### Table of Contents

Introduction – OBD-II and HD OBD .....	5
General Description 6.7L/3.2L Diesel Engines.....	6
System Schematic 3.2L Chassis Certified.....	7
System Schematic 6.7L Chassis Certified.....	8
System Schematic 6.7L Dynamometer Certified.....	9
2015 MY 3.2L I5 Diesel Exhaust Features, Medium Duty, Chassis Cert.....	11
2015 MY 6.7L V8 Diesel Exhaust Features, Medium Duty, Chassis Cert.....	12
2015 MY 6.7L V8 Diesel Exhaust Features, Medium Duty, Dyno Cert.....	12
NON-METHANE HYDROCARBON (NMHC) CONVERTING CATALYST MONITOR .....	13
Diesel Oxidation Catalyst Efficiency Monitor - Functional .....	13
Diesel Oxidation Catalyst Efficiency Monitor – Intrusive .....	14
Diesel Oxidation Catalyst DPF Regeneration Assistance Monitor .....	15
Diesel Oxidation Catalyst SCR Assistance Monitor .....	15
OXIDES OF NITROGEN (NO <sub>x</sub> ) CONVERTING CATALYST MONITORING.....	15
Selective Catalyst Reduction Catalyst Efficiency Monitor .....	15
Selective Catalyst Reduction Feedback Control Monitors .....	17
Exhaust Temperature Controller Monitor .....	18
Selective Catalyst Reduction Tank Level .....	19
MISFIRE MONITOR.....	20
Misfire System Overview .....	20
Misfire Algorithm Processing .....	20
FUEL SYSTEM MONITOR .....	22
Fuel System Overview .....	22
Fuel Rail Pressure Sensor Circuit Check .....	22
Fuel Rail Pressure Sensor Range Check:.....	24
Injector Code Missing/Invalid:.....	31
Fuel system pressure control:.....	32
Fuel Rail Pressure Monitors: .....	32

Injection Timing / Injection quantity .....	34
Fuel Mass Observer (Global Fuel Bias): .....	36
Feedback control: .....	37
Zero Fuel Calibration: .....	37
EXHAUST GAS SENSOR MONITOR .....	41
Air-Fuel Ratio Sensors: Feedgas NOx Sensor Control Module .....	41
Air-Fuel Ratio Sensors: Tailpipe NOx and O2 Sensor Control Module .....	48
Particulate Matter Sensor.....	55
Exhaust Gas Particulate Matter Sensor (PMS) .....	55
Particulate Matter Sensor Sampling Monitor .....	61
Particulate Matter Sensor Regeneration Monitor .....	62
Particulate Matter Filter Monitor Using PM Sensor .....	63
EXHAUST GAS RECIRCULATION (EGR) SYSTEM MONITOR.....	65
EGR Rate System Monitor .....	65
EGR Cooler / EGR Cooler Bypass Monitor .....	68
EGR System Slow Response .....	71
EGR Control Limits Monitor .....	71
Mass Airflow Closed-loop Control Limits Monitor .....	72
BOOST PRESSURE CONTROL SYSTEM MONITORING.....	73
Intrusive Turbo Position and Response Monitoring.....	73
Overboost Monitoring .....	75
Threshold Overboost Monitoring .....	76
Underboost Monitoring .....	77
Charge Air Cooler Monitoring .....	78
PARTICULATE MATTER (PM) FILTER MONITORING .....	80
DPF Filter Efficiency Monitor (3.2L only) .....	80
DPF Filter Missing Substrate Monitor .....	81
DPF Frequent Regeneration Monitor .....	82
DPF Incomplete Regeneration Monitor .....	83
DPF Feedback Control Monitors .....	84
DPF Restriction Monitor.....	85
ENGINE COOLING SYSTEM MONITORING .....	86
Thermostat Monitor.....	86
Primary Coolant Temp Rise Monitoring.....	87
Secondary Coolant Temp Rise Monitoring.....	88
COLD START EMISSION REDUCTION STRATEGY MONITORING.....	89
Cold Start Emission Reduction System Monitor (Only 6.7L Pickup Applications) .....	89
Cold Start Emission Reduction Component Monitor .....	90
Crankcase Ventilation Monitor.....	94

Engine Sensors .....	95
Air Temperature Rationality Test.....	95
Ambient Air Temperature Physical Range Check.....	96
Barometric Pressure and Manifold Absolute Pressure.....	102
Turbine Upstream Pressure Sensor Plausibility Checks.....	104
Upstream Turbine Pressure Sensor Signal Range Check.....	106
EGR Valve Position Sensor.....	106
Throttle Position Sensor .....	106
EGR Downstream Temperature Sensor Dynamic Plausibility Check.....	107
Engine Coolant & Engine Oil Correlation .....	107
Cam and Crank Sensor: .....	111
Mass Air Meter.....	113
MAF Rationality Check .....	114
Air Path Leakage Check.....	116
Turbocharger/Boost Sensor.....	118
DEF Pressure Sensor.....	119
Reductant Pressure Sensor Signal Range Check.....	120
Reductant Pressure Plausibility Check before Start-up .....	120
DEF Pressure Build-up Check at Start-up.....	121
DEF System Pressure Control.....	122
Reductant Tank Level Sensor .....	124
Reductant Tank Level Sensor Circuit Checks.....	125
Reductant Tank Level Sensor Plausibility Check.....	126
Reductant Tank Temperature Sensor .....	126
Reductant Tank Temperature Plausibility Check.....	127
Exhaust Gas Temperature Sensor Rationality Test .....	128
Diesel Particulate Filter Pressure Sensor Rationality Test.....	131
Diesel Particulate Filter Pressure Offset Test.....	132
Delta Pressure Sensor.....	133
Driver Input Devices .....	135
Accelerator Pedal Diagnostics.....	135
Brake Switch Diagnostics .....	135
Engine Outputs .....	136
EGR Valve Actuator Signal Range Check.....	136
EGR Valve Offset Learn Limits.....	136
EGR Valve Actuator Jammed Detection .....	137
Throttle Valve Actuator Signal Range Check .....	138
Throttle Valve Offset Learn Limits .....	138
Throttle Valve Actuator Jammed Detection .....	139

ECB Valve Actuator Signal Range Check .....	140
Urea System Pressure Control .....	140
Reductant Pump Motor .....	141
Reductant Pump Motor Circuit Checks .....	142
Reductant Pump Motor Functional Check .....	142
Reductant Dosing Valve (Injector) .....	143
Reductant Dosing Valve Circuit Checks .....	143
Plausibility Check for Pump Motor Duty Cycle (Clogging) .....	144
Reductant Dosing Valve Functional Check .....	145
Reverting Valve.....	146
Reverting Valve Circuit Checks .....	146
Reverting Valve Functional Check.....	147
Urea Heaters.....	148
Reductant Heater Plausibility Checks .....	148
Lack of Communication Codes:.....	155
Glow Plugs and Glow Plug Control Modujle (GPCM).....	157
Down Stream Injection (DSI) Sytem .....	161
DSI Vaporizer Pump Circuit Continuity Check Monitor .....	161
DSI Vaporizer Glow Plug Circuit Continuity Check Monitor .....	162
DSI Vaporizer Glow Plug Relay Plausibility Check Monitor .....	163
DSI Leakage Monitor .....	164
Turbocharger Actuator Signal Range Check.....	165
Miscellaneous ECU Faults:.....	166
Transmission Park/Neutral Gear Check at Start-Up.....	166
Comprehensive Component Monitor - Transmission .....	167
Transmission Inputs.....	167
Transmission Outputs .....	170
Transmission Control Module (TCM).....	174
6R140 (RWD) Transmission with external PCM or TCM .....	176
On Board Diagnostic Executive.....	179
Exponentially Weighted Moving Average .....	181
Serial Data Link MIL Illumination .....	182
Calculated Load Value .....	183
I/M Readiness .....	183
Power Take Off Mode .....	184
In-Use Monitor Performance Ratio.....	185
Mode \$06 Results.....	186

## **Introduction – OBD-II and HD OBD**

### **Light Duty OBD-II Systems**

#### **On Board Diagnostics II - Passenger Cars, Light-Duty Trucks, and Medium-Duty Vehicles and Engines certified under title 13, CCR section 1968.2**

California OBD-II applies to all California and "CAA Sec. 177 States" for gasoline engine vehicles up to 14,000 lbs. Gross Vehicle Weight Rating (GVWR) starting in the 1996 MY and all diesel engine vehicles up to 14,000 lbs. GVWR starting in the 1997 MY.

"CAA Sec. 177 States" or "California States" are states that have adopted and placed into effect the California Air Resources Board (CARB) regulations for a vehicle class or classes in accordance with Section 177 of the Clean Air Act. At this time, "CAA Sec. 177 States" are Massachusetts, New York, Vermont and Maine for 2004, Rhode Island, Connecticut, Pennsylvania for 2008, New Jersey, Washington, Oregon for 2009, Maryland for 2011, Delaware for 2014 and New Mexico for 2016. These States receive California-certified vehicles for passenger cars and light trucks, and medium-duty vehicles, up to 14,000 lbs. GVWR."

Federal OBD applies to all gasoline engine vehicles up to 8,500 lbs. GVWR starting in the 1996 MY and all diesel engine vehicles up to 8,500 lbs. GVWR starting in the 1997 MY. US Federal only OBD-certified vehicles may use the US Federal allowance to certify to California OBD II but then turn off/disable 0.020" evap leak detection).

Starting in the 2004 MY, Federal vehicle over 8,500 lbs. are required to phase in OBD-II. Starting in 2004 MY, gasoline-fueled Medium Duty Passenger Vehicles (MDPVs) are required to have OBD-II. By the 2006 MY, all Federal vehicles from 8,500 to 14,000 lbs. GVWR will have been phased into OBD-II.

### **Heavy Duty OBD Systems**

#### **Heavy Duty On-Board Diagnostics - Heavy-duty engines (>14,000 GVWR) certified to HD OBD under title 13, CCR section 1971.1(d)(7.1.1) or (7.2.2) (i.e., 2010 and beyond model year diesel and gasoline engines that are subject to full HD OBD)**

Starting in the 2010 MY, California and Federal gasoline-fueled and diesel fueled on-road heavy duty engines used in vehicles over 14,000 lbs. GVWR are required to phase into HD OBD. The phase-in starts with certifying one engine family to HD OBD in the 2010 MY. (2010 MY 6.8L 3V Econoline) By the 2015 MY, all engine families must certify to the HD OBD requirements. Vehicles/engines that do not comply with HD OBD during the phase-in period must comply with EMD+.

OBD-II system implementation and operation is described in the remainder of this document.

## General Description 6.7L/3.2L Diesel Engines

The 6.7L is a V8 engine designed to meet customer expectations of high horsepower and torque with exceptional fuel economy and low NVH. It must do this while meeting the tough emissions standards set by the EPA and CARB.

Some of the technologies employed to meet these diverse criteria include a Variable Geometry Turbocharger (VGT), common rail fuel injection system, electronically controlled, cooled EGR, a diesel oxidation catalyst (DOC), Selective Catalytic Reduction catalyst (SCR), Diesel Exhaust Fluid (DEF) injection system, and a diesel particulate filter (DPF).

The system schematic on the next page shows the path of the air as it is compressed by the turbocharger, cooled by the air-to-coolant intercooler, and mixed with the cooled EGR gases. The state of this compressed and heated air is sensed by the manifold absolute pressure (MAP) sensor just before it enters the cylinders and the two temperature sensors that represent Charge Air Cooler Outlet temperature (CACT1) and EGR Cooler outlet temperature (EGRCOT). The exhaust gas pressure is measured by the exhaust backpressure (EP) sensor before it exits through the turbocharger. The exhaust after treatment system consists of a DOC, a SCR, a DPF and a muffler.

An electronic, proportional valve controls EGR rates with an integral position sensor (EGRP). Flows are determined by valve position and the amount that backpressure exceeds boost pressure. An EGR throttle (EGRTP) is used for regeneration control as well as to optimize the boost pressure vs. backpressure levels.

Fuel injection pressure is measured by the high-pressure fuel rail sensor (FRP). Injection pressure is controlled by the high pressure pump and two regulating valves, a Pressure Control Valve (PCV), and a Fuel Metering Unit (MeUn), formerly known as Volume Control Valve (VCV).

Engine speed (N) and crankshaft position are determined by the crankshaft position sensor (CKP) which senses a 60 minus 2 tooth target wheel. Camshaft position is determined by the camshaft position sensor (CMP), which senses the profile of a multiple lobed camshaft.

Atmospheric pressure is determined by the Barometric Pressure sensor (BARO) mounted internally in the Engine Control Module (ECM).

During engine operation, the ECM calculates engine speed from the crankshaft position sensor. The ECM controls engine operation by controlling the piezo injector opening and closing times as well as the pressure at which the fuel is injected, thereby controlling fuel quantity and timing. Simultaneously, airflow is modulated by controlling the turbocharger vane position.

Fuel quantity is controlled by injector "on time" (pulse width) and the fuel rail pressure. Desired engine speed is determined from the position of the accelerator pedal.

The 3.2L I5 engine has the same technologies and engine layout employed on the 6.7L V8 engine with some exceptions. See engine diagram below.

# System Schematic 3.2L Chassis Certified



## V363N Engine Controls System Hardware

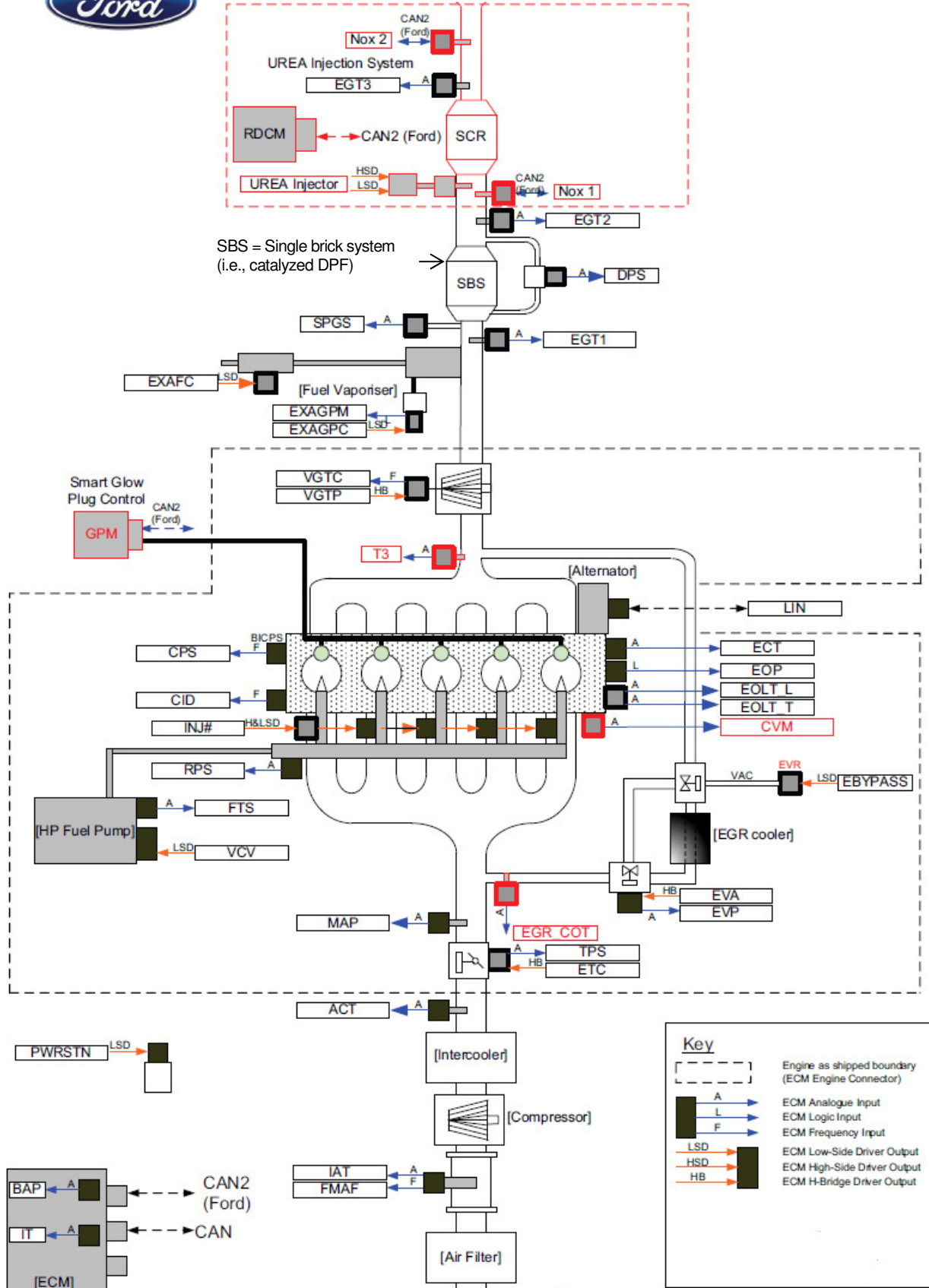

# System Schematic 6.7L Chassis Certified

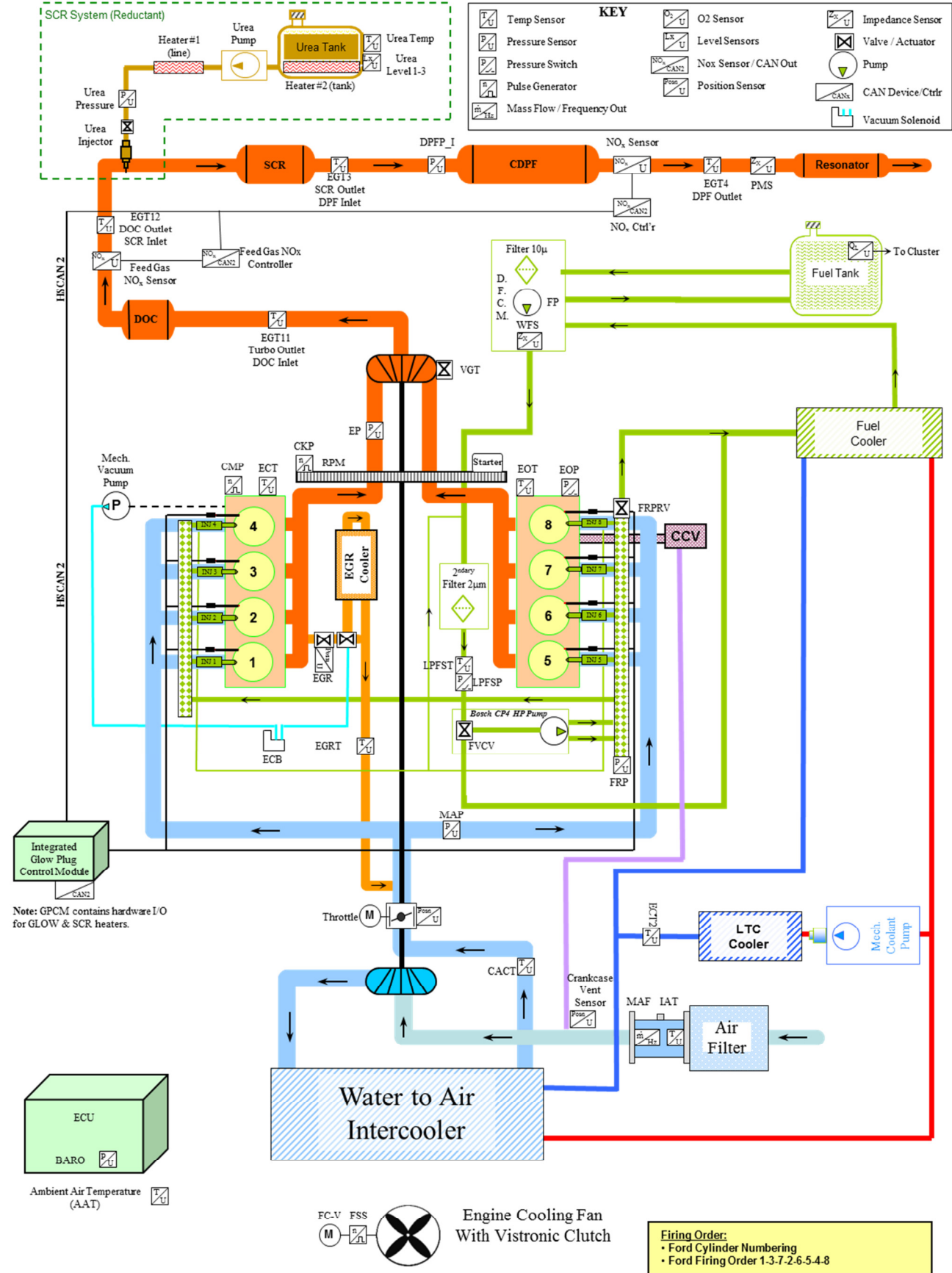





Actuators	Acronym	Sensors	Acronym
DEF (Reductant) System			
DEF Pump		DEF Temp-Level Combination Sensor	
DEF Tank Heater	Heater #1	DEF Pressure Sensor	
DEF Pump & Line Heater	Heater #2		
DEF Injector			
NOx Sensor System			
Feedgas NOx Sensor Controller	NOx11	NOx Sensor	
Tailpipe NOx Sensor Controller	NOx12	NOx Sensor	
Reductant Control Module	RDCM		
Boost System			
Variable Geometry Turbo Control	VGTC	Manifold Pressure Sensor	MAP
		Charge Air Cooler Temperature at Outlet	CACT1
Variable Nozzle Turbocharger Motor	VNT	Mass Airflow Sensor	MAF
		Intake Air Temperature	IAT11
		Exhaust Back Pressure	EBP or P3
Exhaust Gas Recirculation System			
Exhaust Gas Recirculation Valve Control	EGRVC	Exhaust Gas Recirculation Valve Position	EGRVP
Exhaust Gas Recirculation Cooler Bypass Vacuum Control Solenoid	EGRCBV	Exhaust Gas Recirculation Cooler Gas Temperature at Outlet	EGR_COT
EGR Throttle Motor Control	TACM	EGR Throttle Position Sensor	TPS
Fuel System			
High Pressure Fuel Volume Control Valve	FVCV	High Pressure Fuel Rail Pressure Sensor	FRPS
High Pressure Fuel Pressure Relief Valve	FRPRV	Low Pressure Fuel Delivery Switch	FDPS
Fuel Injectors	INJ 1-8	Low Pressure Fuel Temperature Sensor	FTS
Low Pressure Fuel Pump and Filters	DFCM		
Water In Fuel Sensor	WFS		
Fuel Tank Level Sensor			
Glow Plug System			
Glow Plugs			
Glow Plug Controller	GPCM		
Exhaust System			
		Diesel Oxidation Inlet Temperature	DOC_IT or EGT11
		Diesel Oxidation Outlet Temperature	DOC_OT or EGT12
		Selective Catalytic Reduction Outlet Temperature	SCR_OT or EGT 13
		Upstream Catalyzed Diesel Particulate Filter Pressure	DPFP
		Downstream Diesel Particulate Filter Temperature	DPF_OT or EGT 14
		Single Pressure Gauge Sensor	SPGS
Engine System			
Electric Clutch Fan Controller	FC-V	Cam Shaft Position Sensor	CMP
		Engine Coolant Temperature	ECT
		Crank Shaft Position Sensor	CKP
		Engine Oil Temperature	EOT
		Engine Oil Pressure Switch	EOP_SW
		Low Temperature Coolant Loop Temperature	ECT2
		Engine Fan Speed Sensor	FSS
		Environmental Temperature Sensor	ENV_T
		Barometric Pressure Sensor	BARO

## 2015 MY 3.2L I5 Diesel Exhaust Features, Medium Duty, Chassis Cert

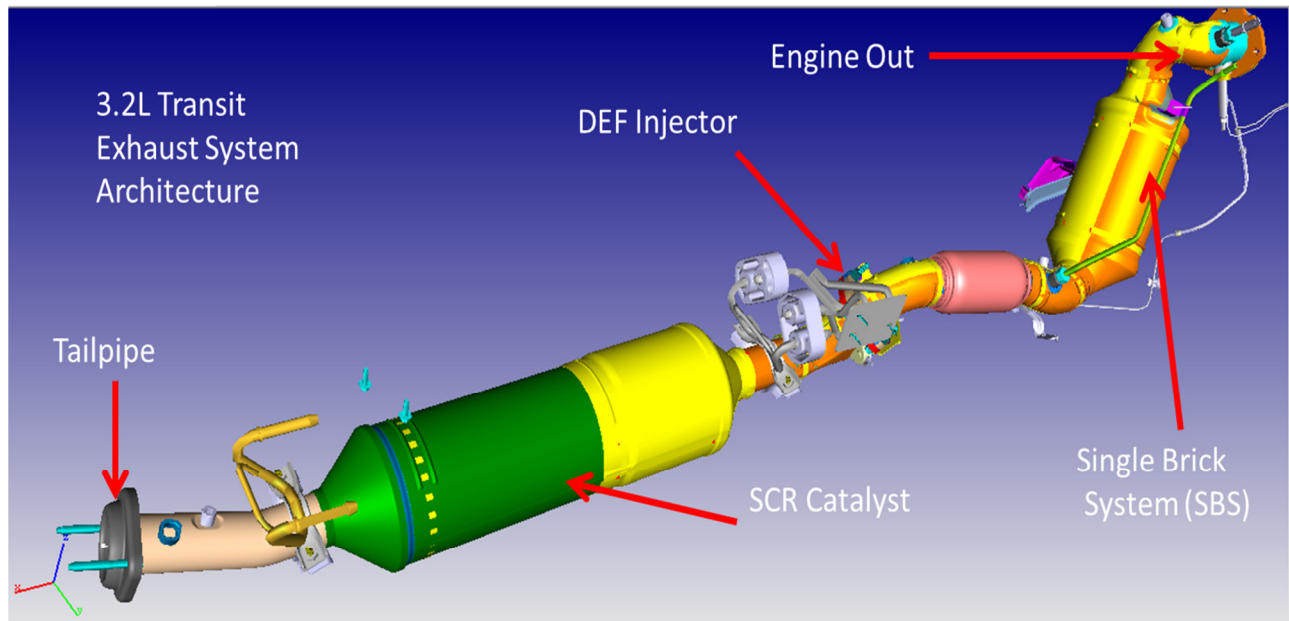

Exhaust system architecture for the 6.7L Diesel

The dynamometer certified application of the 6.7L diesel engine has a similar layout to the chassis certified version. The main difference is a change in the order of the aftertreatment systems. The dynamometer certified 6.7L exhaust system layout is shown below:

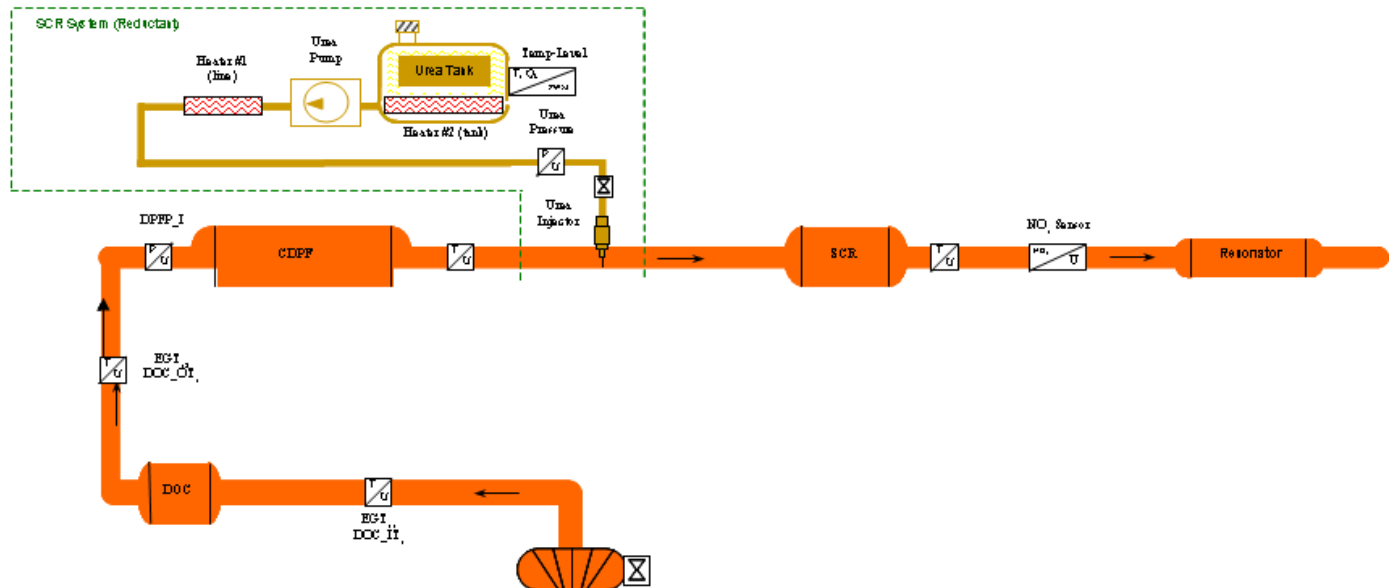

**2015 MY 6.7L V8 Diesel Exhaust Features, Medium Duty, Chassis Cert**

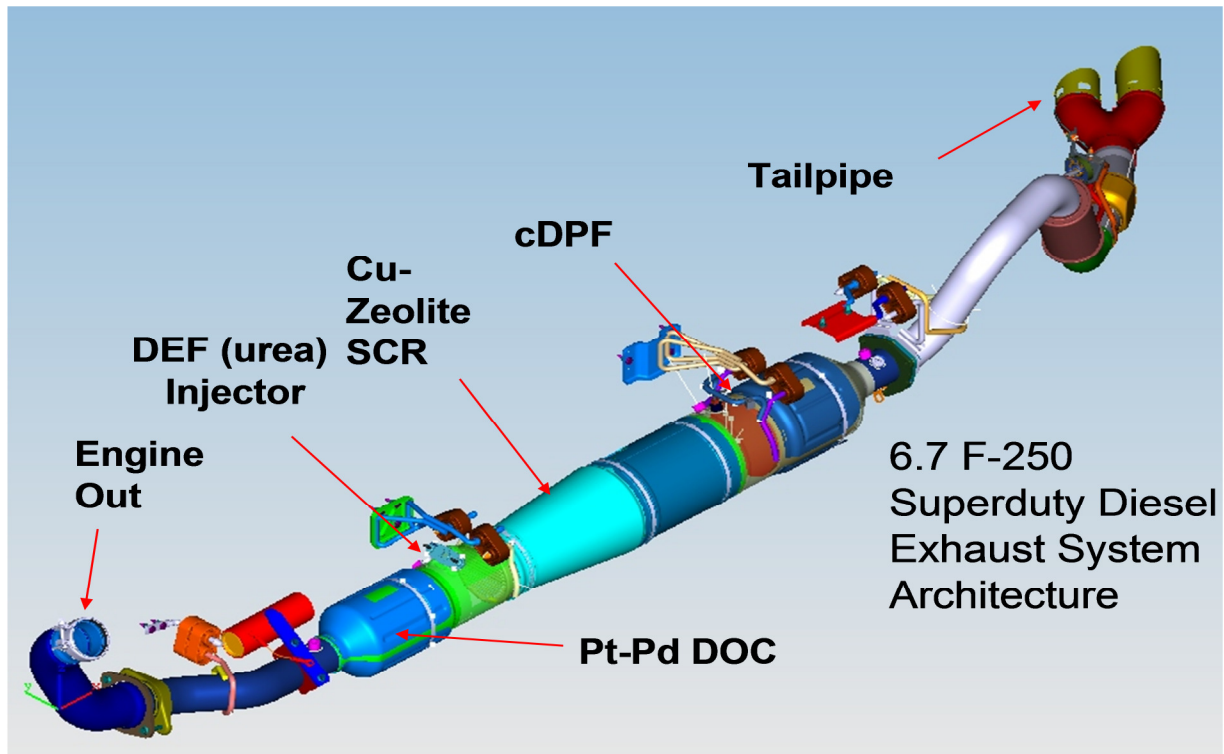

**2015 MY 6.7L V8 Diesel Exhaust Features, Medium Duty, Dyno Cert**

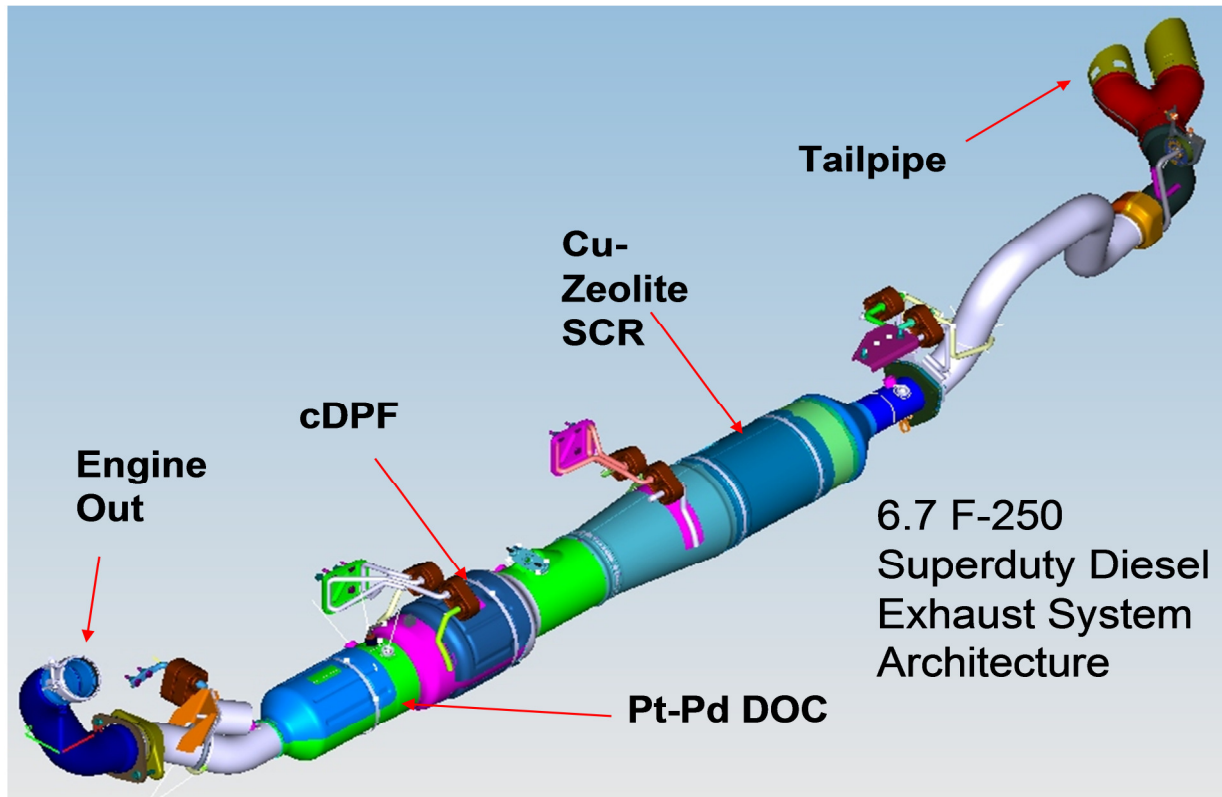

# NON-METHANE HYDROCARBON (NMHC) CONVERTING CATALYST MONITOR

## Diesel Oxidation Catalyst Efficiency Monitor - Functional

The Diesel Oxidation Catalyst (DOC) is monitored to ensure it is capable of converting hydrocarbons and carbon monoxide. The monitor is only run during aftertreatment regeneration events. After entering regen, there is a short delay to allow the DOC to achieve light-off temperature. Then the exotherm is monitored for a short period of time and normalized versus an expected exotherm (a function of post-injection fuel quantity and ambient air temp). The exotherm is defined as the DOC outlet temperature (EGT12) minus the DOC inlet temperature (EGT11). The normalized exotherm is filtered for a short period of time, and then compared to a threshold. If the normalized exotherm is below the threshold, a fault is indicated. No other preconditioning is required.

This monitor applies to >10,000 GVW 6.7L pickups, all 6.7L chassis cabs, and all 3.2L products.

### DOC Efficiency Monitor Summary:

DTCs	P0420 – Catalyst System Efficiency Below Threshold
Monitor execution	Once per driving cycle during which an active DPF regeneration occurs
Monitor Sequence	None
Sensors OK	EGT11, EGT12, ECT, MAF, IAT
Monitoring Duration	4 minutes

### Typical DOC Efficiency Monitor Entry Conditions:

Entry condition	Minimum	Maximum
DPF regeneration event		
Engine speed	1000 rpm	3000 rpm
Torque set point	100 Nm	1000 Nm
Engine coolant temperature	70 deg C	
DOC inlet temperature	200 deg C	500 deg C
PTO inactive		

### Typical DOC Efficiency Monitor Malfunction Threshold:

Normalized exotherm is less than 40% of the expected exotherm for 60 seconds

## Diesel Oxidation Catalyst Efficiency Monitor – Intrusive

The Diesel Oxidation Catalyst (DOC) is monitored to ensure it is capable of converting hydrocarbons and carbon monoxide. While entry conditions are met, a small quantity of fuel is post-injected late in the combustion cycle (similar injection timing as DPF regen). The actual exothermic efficiency is calculated from the temperature rise across the DOC and normalized by the expected exothermic efficiency (based on quantity of fuel injected), which results in a ratio having values between 0-1. If the normalized exotherm is below the threshold, a fault is indicated. No other preconditioning is required.

The Intrusive DOC Monitor is only applicable on <10,000 GVW 6.7L pickups.

<b>DOC Efficiency Monitor Summary:</b>	
DTCs	P0420 – Catalyst System Efficiency Below Threshold
Monitor execution	Once every 400 km
Monitor Sequence	None
Sensors OK	EGT11, EGT12, ECT, MAF, IAT
Monitoring Duration	With valid entry conditions:  Monitor session: 75 sec (includes time to post-inject fuel and calculate metric)  Total time: Approx. 8 minutes (3 sessions required in order to complete, 120 sec wait time between sessions)

<b>Typical DOC Efficiency Monitor Entry Conditions:</b>		
Entry condition	Minimum	Maximum
Distance since last monitor completion	400 km	
Time since entering normal Engine Operating Mode (EOM0)	300 sec (if transitioning from EOM1/2 (Regen), EOM3 (Catalyst Warmup)  600 sec (if transitioning from Aftertreatment Overheat mode)	
Pre-DOC Temp	210 deg C	280 deg C
Post-DOC Temp	210 deg C	1000 deg C
Exhaust Mass Flow Rate	70 kg/hr	1000 kg/hr
Post Injection Fuel (from requests other than this monitor)	-10 mg/stroke	10 mg/stroke
Engine coolant temperature	70 deg C	
Ambient Air Temperature	-6.7 deg C	
Barometric Pressure	75.5 kPa	
Engine speed	1000 rpm	
Torque set point	50 Nm	

<b>Typical DOC Efficiency Monitor Malfunction Threshold:</b>
Monitor requires 3 failing results in order to diagnose a failed DOC. Normalized exotherm efficiency must be less than 30% of expected for all 3 monitor sessions.

## Diesel Oxidation Catalyst DPF Regeneration Assistance Monitor

The DOC is monitored to ensure it is capable of generating a sufficient exotherm to allow DPF regeneration events by burning the soot which is stored in the Diesel Particulate Filter (DPF). This is accomplished with the same diagnostic described above for the DOC Catalyst Efficiency Monitor.

## Diesel Oxidation Catalyst SCR Assistance Monitor

The DOC in this system is not utilized to provide any changes in the feedgas constituency that would aid in the proper SCR operation.

# OXIDES OF NITROGEN (NO<sub>x</sub>) CONVERTING CATALYST MONITORING

## Selective Catalyst Reduction Catalyst Efficiency Monitor

The SCR catalyst is monitored to ensure it is capable of NO<sub>x</sub> conversion. NO<sub>x</sub> concentrations upstream and downstream of the SCR are measured with NO<sub>x</sub> sensors. Using these concentrations, the cumulative efficiency of the SCR catalyst is calculated and compared to a threshold. If the cumulative efficiency is below this threshold at the end of the sample period (approx 1 minute), a fault will be indicated.

The reductant, Diesel Exhaust Fluid (DEF), which is used as part of the SCR catalyst reaction, is monitored to ensure the tank is not refilled with an improper reductant. After the SCR Catalyst Efficiency Monitor has completed and the SCR has been determined to be functional, the efficiency monitor continues to calculate the cumulative efficiency of the system, with a calibrated wait time between iterations of the monitor. Successive values for cumulative efficiency are included in two filtering routines, one for short term efficiency and the other for long term efficiency. The short term efficiency must be less than a threshold (0.35-0.55, depending on application) and the difference between short and long term conversion efficiency must be greater than a threshold (0.10).

Monitor Summary:	
DTCs	P20EE – SCR NO <sub>x</sub> Catalyst Efficiency Below Threshold P207F – Reductant Quality Performance P204F – Reductant System Performance (Bank 1)
Monitor execution	P20EE - Once per driving cycle P207F – Continuously (while entry conditions are met) P204F - Continuously
Monitor Sequence	P20EE test followed by P207F test
Sensors OK	NO <sub>x</sub> , EGT12, EGT13, ECT, DEF injection system, MAF, BARO, O <sub>2</sub> , DPFP, EGR system
Monitoring Duration	P20EE – 2 Minutes, P207F – Dependent on driving conditions and DEF dilution P204F - Continuous

**Typical Entry Conditions:**

Entry condition	Minimum	Maximum
SCR Feedback Control Enabled		
FG and TP NOx sensors ready (light-off temp reached and internal checks complete)		
Regeneration Cycle Not Requested		
Engine coolant temperature	70 deg C	
Ambient air temperature	-6.7 degC	
Barometric Pressure	81.2 kPa	120 kPa
Engine Speed	1000 rpm	3000 rpm
Torque Transients	-30 N-m/s,	+10 N-m/s
Exhaust Space Velocity	5000 /hr	120,000 /hr
SCR Inlet temp	180 degC	320 degC
Filtered rate of change of SCR inlet temp		30 seconds
Feedgas NOx	75 ppm	800 ppm
DEF storage	40% understored	10% overstored
Minimum NH3 storage	0.75 grams	
Delay between iterations of monitor (for DEF Quality monitor)	1400 sec	
Short term efficiency (DEF Quality monitor)		0.35-0.55 (depends on application)
Short term to long term efficiency delta (DEF Quality monitor)	0.1	

**Typical Malfunction Thresholds:**

P20EE: If the cumulative efficiency of the SCR Catalyst is less than 35% for approx 60 seconds., a fault is indicated.

P207F: the short term NOx efficiency needs to be less than a threshold (0.35-0.55) and the delta between short and long term efficiency needs to be greater than 0.10. The fault will generally be detected within 1 hour under most conditions.

P204F: If CAN communication with the RDCM is lost OR the RDCM reports a fault which requires MIL illumination



## Selective Catalyst Reduction Feedback Control Monitors

The SCR system is monitored to ensure the proper closed loop control of the reductant injection. As part of the reductant injection control, a correction factor is adapted to account for long term drift of the system (injector, etc). This correction factor is monitored continuously. If the correction factor reaches a threshold in the positive or negative direction for a sufficient period of time, a fault will be indicated.

A SCR Time to Closed Loop monitor is implemented to ensure that SCR feedback occurs when expected. Once entry conditions are met, a timer is incremented. If the fraction of time in closed loop control is less than a threshold, a fault is indicated.

Additionally, the system has a temperature controller that increased the tailpipe temperatures under certain situations to improve the function of the SCR system. This controller is also monitored.

<b>Monitor Summary:</b>	
DTCs	P249D – SCR Feedback at Minimum Limit P249E – SCR Feedback at Maximum Limit P249C – SCR Time to Closed Loop
Monitor execution	Continuous
Monitor Sequence	None
Sensors OK	NOx, EGT12, EGT13, ECT, EGT11 EGT14, MAF, BARO, IAT, DPFP, and EGR system
Monitoring Duration	5 minutes

<b>Typical Entry Conditions:</b>		
Entry condition	Minimum	Maximum
Low Temp Adaptation is enabled (Feedback monitor only)		
Engine speed	800 rpm	3000 rpm
Torque set point	0 Nm	1000 Nm
Barometric pressure	74.5 kPa	
Ambient temperature	-6.7 deg C	
Engine coolant temperature	70 deg C	
SCR temperature	160 deg C	550 deg C

<b>Typical Malfunction Thresholds:</b>
P249D: If the correction factor is clipped at its minimum value for 30 seconds then a fault is indicated.
P249E: If the correction factor is clipped at its maximum value for 30 seconds then a fault is indicated.
P249C: The error is set as soon as the fraction of closed loop operation vs expected is less than the threshold. The monitor needs to run for 300 seconds to call it complete.

## Exhaust Temperature Controller Monitor

The monitoring of exhaust temperature is done by comparing the temperature deviation between the setpoint temperature and the actual measured temperature with a maximum allowed deviation threshold.

Monitor Summary:	
DTCs	P22FF – SCR NOx Catalyst Inlet Temperature Too Low
Monitor execution	Continuous while entry conditions are meet
Monitor Sequence	None
Sensors OK	EGT12, ECT, BARO, ENV_T, CKP, EGR system, Fuel injection system, PCV,
Monitoring Duration	300 seconds - Dependent on driving condtions

Typical Entry Conditions:		
Entry condition	Minimum	Maximum
Engine speed	800 rpm	1600 rpm
Torque set point	50 Nm	600 Nm
Barometric pressure	80 kPa	
Ambient temperature	2.96 deg C	
Engine coolant temperature	17.46 deg C	
Normal Engine Operation Mode		

Typical Malfunction Thresholds:
The error is set if the measured SCR inlet temp is more than 80 deg C below the setpoint for 300 seconds.

## Selective Catalyst Reduction Tank Level

The SCR system is monitored to ensure the level of DEF in the reductant tank is sufficient to achieve system performance. As part of the DEF level customer warning system, a fault will be recorded when the calculated mileage remaining of DEF is equal to 200 miles (The discrepancy between actual and reported mileage is due to expected tolerance of calculations). The calculated mileage remaining is derived from the three pin level sensor in the tank and the volume of DEF commanded to be injected over distance. This fault will be erased once the system senses a DEF refill event.

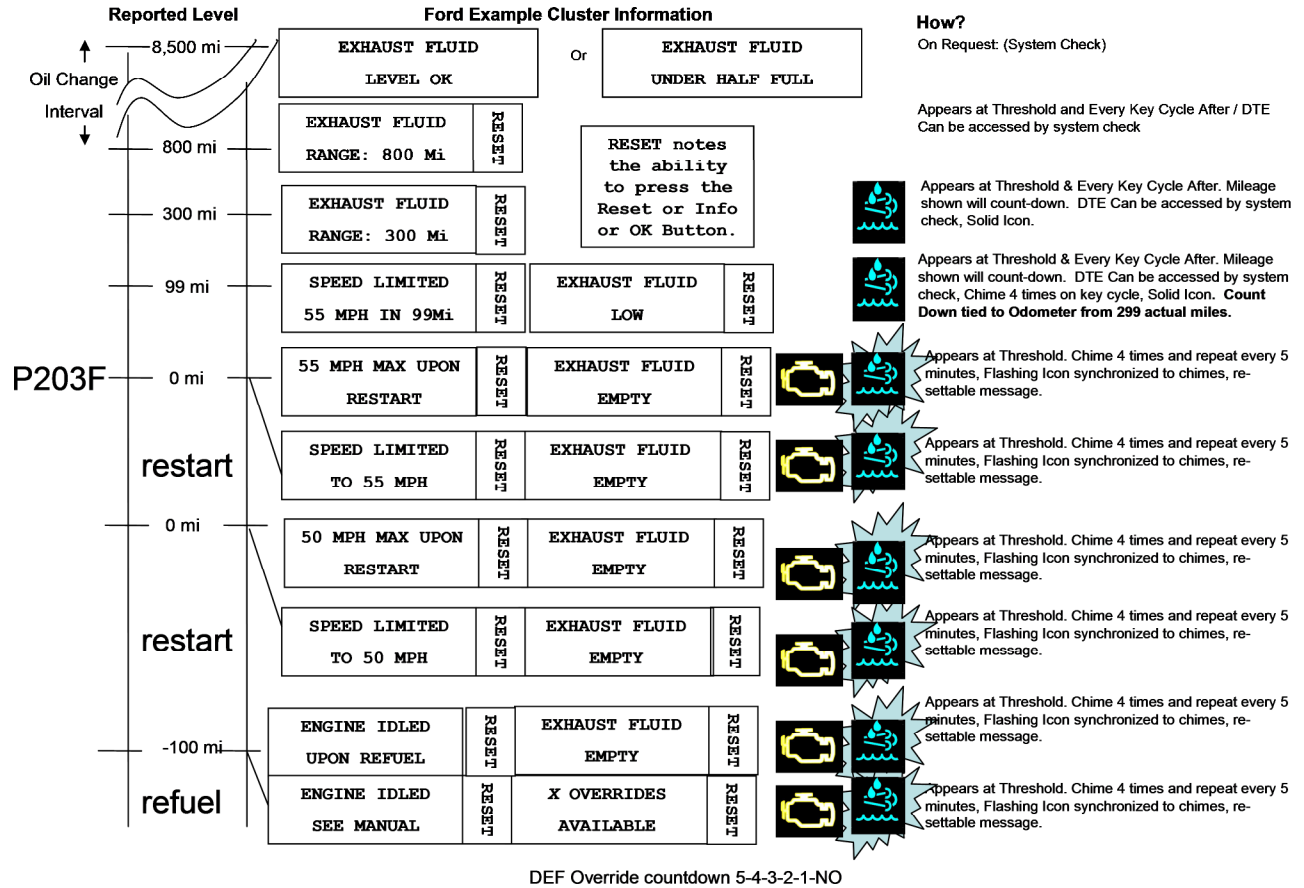

Monitor Summary:	
DTCs	P203F - Reductant Level Too Low
Monitor execution	Continuous
Monitor Sequence	None
Sensors OK	DEF Temp-Level Combination Sensor

# MISFIRE MONITOR

## Misfire System Overview

The 3.2L and 6.7L Diesel engine utilizes a Hall Effect sensor (CKP) that processes the edges of a 60-2 tooth stamped target wheel mounted on the crankshaft. The software gets an edge every 3 degrees and these edges are used for fuel injection timing, fuel quantity control, and the calculation of engine speed. A software algorithm corrects for irregularities of the teeth of the target wheel to improve crankshaft signal resolution. A second Hall effect sensor is used to process the edges of the three-lobed camshaft (CMP) target. The CMP signal and the window of 2 missing teeth on the crankshaft target wheel indicate proper camshaft to crankshaft position for correct cylinder timing.

## Misfire Algorithm Processing

The Misfire Monitor divides two rotations of the crankshaft into 16 half-segments, each 45 degrees of crankshaft rotation. The crankshaft speed shows increases due to combustion of fuel in the cylinder followed by decreases due to friction and other forces between cylinder firing events. The location of the half-segments is chosen such that for each cylinder one half-segment contains the majority of the higher crankshaft speed values (the "high" half-segment) and the other half-segment the majority of the lower crankshaft speed values (the "low" half-segment). The range of crankshaft speed within each half-segment is averaged. The sum of the eight low half-segment speeds is subtracted from the sum of the eight high half-segment speeds and the result divided by eight to get an average increase in speed due to combustion. The Misfire Monitor then calculates the difference between the high and low half-segments for a specific cylinder combustion event and increments a misfire counter for the firing cylinder if this value is less than 20% of the average increase in speed due to combustion described above.

The Misfire Monitor collects blocks of data consisting of 20 crankshaft rotations. Upon achieving the correct entry conditions for the Misfire Monitor as described below, the first block of 20 rotations is discarded to ensure stable idle operation. All subsequent blocks of data are counted unless vehicle conditions change such that the entry conditions are no longer satisfied. In this case, any data in the current partial block are discarded, along with the data from the block immediately prior, as stable idle cannot be ensured for these data. The Misfire Monitor completes once 50 valid blocks (1000 crankshaft revolutions) have been collected, and a fault is reported if a cylinder shows 350 or more misfire events (out of 500 possible combustion events) in this time.

Certain engine operating parameters are monitored to ensure misfire operates in a region that yields accurate misfire results. The table below outlines the entry conditions required for executing the misfire monitor algorithm.

**Misfire Monitor Operation:**

DTCs	P0300 – Random Misfire Detected P0301 – Cylinder 1 Misfire Detected P0302 – Cylinder 2 Misfire Detected P0303 – Cylinder 3 Misfire Detected P0304 – Cylinder 4 Misfire Detected P0305 – Cylinder 5 Misfire Detected P0306 – Cylinder 6 Misfire Detected P0307 – Cylinder 7 Misfire Detected P0308 – Cylinder 8 Misfire Detected
Monitor execution	Continuous, at idle
Monitor Sequence	None
Sensors OK	Engine Coolant Temperature (ECT), Vehicle Speed (VSS), Crankshaft Position Sensor (CKP) Injector Faults, Injector Bank Faults
Monitoring Duration	1000 revs

**Typical Misfire Monitor Entry Conditions:**

Entry condition	Minimum	Maximum
Engine Speed (Idle)	500 rpm	1150 rpm
Engine Coolant Temperature (ECT)	-7 deg C	
Vehicle Speed (VSS)		<= 2 km/hr
Total fuel mass	2.0 mg/stroke	40.0 mg/stroke

# FUEL SYSTEM MONITOR

## Fuel System Overview

Fuel injection pressure is measured by the high-pressure fuel rail sensor (FRP). Injection pressure is controlled by the high pressure pump and two regulating valves, a Pressure Control Valve (PCV), and a Fuel Metering Unit (MeUn), formerly known as Volume Control Valve (VCV).

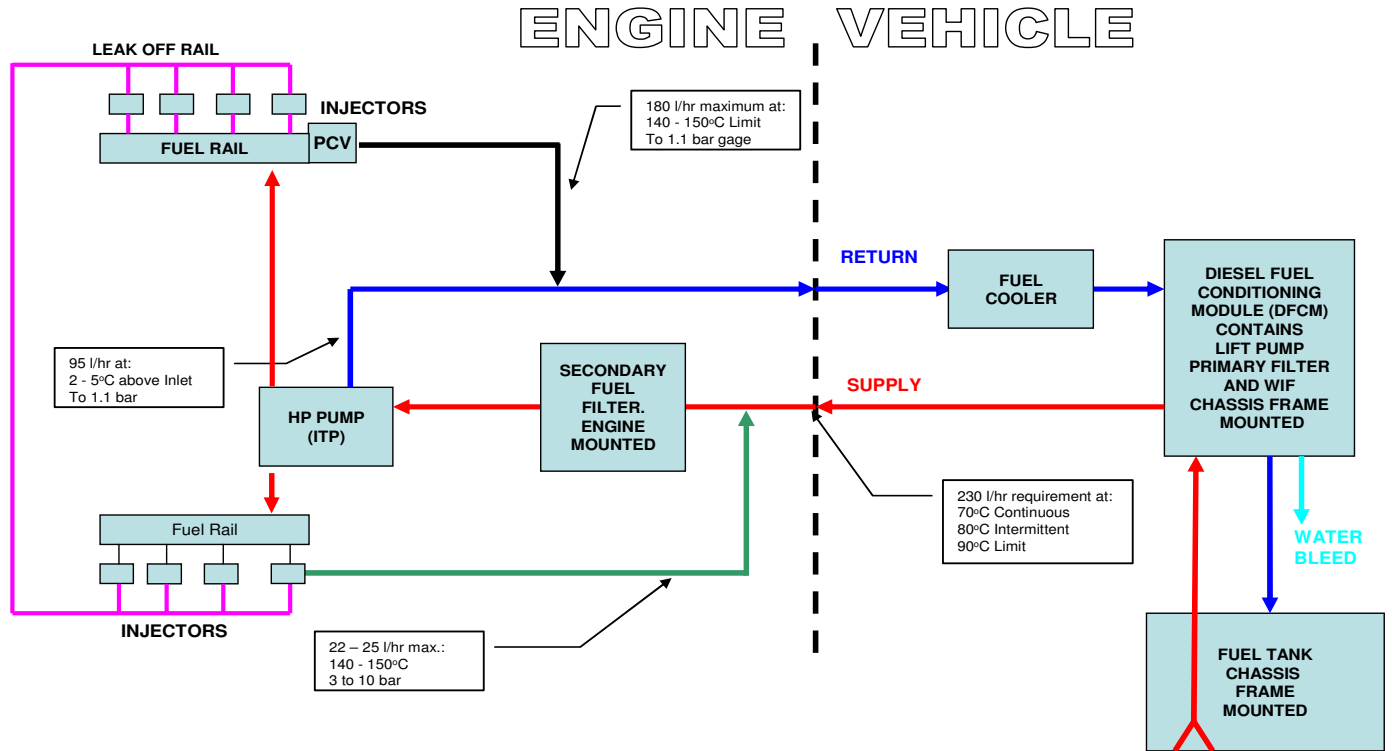

## Fuel Rail Pressure Sensor Circuit Check

Fuel Rail Pressure ( FRP ) Sensor Circuit Check:	
DTCs	P0192 - Fuel Rail Pressure Sensor A Circuit Low Input P0193 - Fuel Rail Pressure Sensor A Circuit High Input
Monitor Execution	Continuous
Monitor Sequence	None
Sensors OK	Sensor Supply Voltage 1 OK (P06A6)
Typical Monitoring Duration	0.5 sec

Typical Fuel Rail Pressure Sensor Circuit Check Malfunction Thresholds:
FRP voltage < 0.13 V, or > 3.17 V

**Fuel Rail Pressure ( FRP ) Sensor Circuit Intermittent Check:**

DTCs	P0194 - Fuel Rail Pressure Sensor Circuit Intermittent/Erratic (Bank 1)
Monitor Execution	Continuous
Monitor Sequence	None
Sensors OK	Sensor Supply Voltage 1 OK (P06A6) FRP (P0192, P0193)
Typical Monitoring Duration	4 sec

**Typical Fuel Rail Pressure Sensor Circuit Intermittent Malfunction Thresholds:**

FRP gradient > 60 MPa

**Fuel Rail Pressure ( FRP ) Rationality Check Operation:**

DTCs	P0191 - Fuel Rail Pressure Sensor "A" Circuit Range/Performance
Monitor Execution	Immediately Prior to Crank and After Key-off
Monitor Sequence	None
Sensors OK	Sensor Supply Voltage 1 OK (P06A6), FRP OK (P0192, P0193)
Typical Monitoring Duration	0.5 sec

**Typical Fuel Rail Pressure Rationality Check Entry Conditions:**

Entry condition	Minimum	Maximum
Pre-crank: engine coolant temperature	-7 deg C	
Pre-crank: time engine off	600 sec	
After key-off: fuel temperature	-40 deg C	
After key-off: time since key off	12 sec	

**Typical Fuel Rail Pressure Rationality Malfunction Thresholds:**

FRP voltage < 0.251 V (-40 bar) or > 0.384 V (68 bar).

## Fuel Rail Pressure Sensor Range Check:

When fuel rail pressure is controlled by the Pressure Control Valve, the Pressure Control Valve signal needed to maintain rail control is compared to an expected value. An adaptation factor for the Pressure Control Valve is calculated from the difference between observed and expected control values. Inaccuracy in the Rail Pressure Sensor Signal Slope is a potential cause of inaccuracy in the needed Pressure Control Valve signal along with physical errors in the PCV itself. If the adaptation factor required for the Pressure Control Valve exceeds a minimum or maximum control limit, then a code is set for rail pressure slope out of acceptable range.

Fuel Rail Pressure ( FRP ) Range Check Operation:	
DTCs	P016D - Excessive Time To Enter Closed Loop Fuel Pressure Control P228E - Fuel Pressure Regulator 1 Exceeded Learning Limits - Too Low P228F - Fuel Pressure Regulator 1 Exceeded Learning Limits - Too High
Monitor Execution	Continuous
Monitor Sequence	None
Sensors OK	Sensor Supply Voltage 1 (P06A6), FRP (P0192, P0193)
Typical Monitoring Duration	P016D – 30 sec, P228E, P228F - 10 sec

Typical Fuel Rail Pressure Range Check Entry Conditions:		
Entry condition	Minimum	Maximum
P016D:		
Requested rail pressure	500 bar	1200 bar
Change in requested rail pressure		30 sec
Fuel temperature		40 deg C
P228E, P228F:		
Rail pressure set point	500 bar	1200 bar
Fuel Temperature		40 deg C
Time since engine start		30 sec

Typical Fuel Rail Pressure Range Check Malfunction Thresholds:
P016D: If the system is within the adaptation operating conditions, but fails to learn a new adaptation factor after 30 seconds, this DTC is set.
P228E, P228F: If the adaptation factor exceeds positive or negative thresholds which correspond to approximately a 20% deviation in the Rail Pressure Sensor slope, a DTC is set.



**Fuel Temperature Sensor Circuit Check Operation:**

DTCs	P0180 – Fuel Temperature Sensor "A" Circuit P0181 – Fuel Temperature Sensor "A" Circuit Range/Performance P0182 – Fuel Temperature Sensor "A" Circuit Low P0183 – Fuel Temperature Sensor "A" Circuit High P0184 – Fuel Temperature Sensor "A" Circuit Intermittent
Monitor Execution	Continuous
Monitor Sequence	None
Sensors OK	None
Typical Monitoring Duration	0.5 sec

**Typical Fuel Temperature Sensor Circuit Check Entry Conditions:**

Entry condition	Minimum	Maximum
P0181:		
Engine Off Time	6 hours	

**Typical Fuel Temperature Sensor Circuit Check Malfunction Thresholds:**

P0181: If after an 6 hour engine off soak, the difference in temperature between the fuel temperature sensor and the charge air cooler outlet temperature sensor exceeds 40 deg C or if the difference in temperature between the fuel temperature sensor and the charge air cooler outlet temperature sensor exceeds 20 deg C and no active block heater is detected, a DTC is set

P0182, P0183: FTS voltage < 0.0946 V (0.1224 V = 150 deg C) or > 4.918 V (4.762 V = -40 deg C)

P0184: If the rate of change of FTS reading is > 10 deg C/100 ms, this DTC is set.

**Volume Control Valve (VCV) Monitor Operation:**

DTCs	P0001 - Fuel Volume Regulator Control Circuit / Open P0002 - Fuel Volume Regulator Control Circuit Range/Performance P0003 - Fuel Volume Regulator Control Circuit Low P0004 - Fuel Volume Regulator Control Circuit High
Monitor Execution	Continuous
Monitor Sequence	None
Sensors OK	None
Typical Monitoring Duration	0.3 sec

**Typical Volume Control Valve Monitor Malfunction Thresholds:**

P0001 – If the volume control valve is not energized and the voltage from the volume control valve control chip is in the range 2.8 – 4.8 V (normal operation: 5V secondary voltage supply)

P0002 – Temperature of powerstage driver on ECM > 170 deg C

P0003 – If the volume control valve is not energized and the observed voltage from the volume control valve control chip is less than 2.8V (normal operation: 5V secondary voltage supply)

P0004 – If the volume control valve is energized and the current to the volume control valve exceeds 3.7A (normal operation: 2.2A maximum)

**Fuel Volume Regulator Control Valve (VCV) Monitor Operation:**

DTCs	P000E - Fuel Volume Regulator Control Exceeded Learning Limit P228D - Fuel Pressure Regulator 1 Exceeded Control Limits - Pressure Too High
Monitor Execution	Continuous
Monitor Sequence	None
Sensors OK	FRP (P0191, P0192, P0193)
Typical Monitoring Duration	P000E – 50 sec, P228D – 1 sec

**Typical Volume Control Valve Monitor Malfunction Thresholds:**

P000E – adaption value is outside of -99.90 and 1500 ml/mm, code is set

P228D – Fuel rail pressure < 100 MPa and relative deviation of fuel pressure difference is 5%, code is set

**Fuel Pressure Control Valve (PCV) Monitor Operation:**

DTCs	P0089 - Fuel Pressure Regulator Performance P0090 - Fuel Pressure Regulator Control Circuit P0091 - Fuel Pressure Regulator Control Circuit Low P0092 - Fuel Pressure Regulator Control Circuit High
Monitor Execution	Continuous
Monitor Sequence	None
Sensors OK	None
Typical Monitoring Duration	0.3 sec

**Typical Fuel Pressure Control Valve Monitor Malfunction Thresholds:**

P0089 – Temperature of power stage driver on ECM is > 170 deg C

P0090 – The pressure control valve is not energized and the voltage from the pressure control valve control chip is in the range 2.8 – 4.8 V (normal operation: 5V secondary voltage supply)

P0091 – The pressure control valve is not energized and the voltage from the pressure control valve control chip is less than 2.8V (normal operation: 5V secondary voltage supply)

P0092 – The pressure control valve is energized and the observed current to the pressure control valve exceeds 5.1A (normal operation: 3.7A maximum)

**Fuel Low Pressure Lift Pump Monitor Operation:**

DTCs	P0627 - Fuel Pump "A" Control Circuit / Open P0628 - Fuel Pump "A" Control Circuit Low P0629 - Fuel Pump "A" Control Circuit High P062A – Fuel Pump "A" Control Circuit Range/Performance P0230 – Fuel Pump Primary Circuit P0231 – Fuel Pump Secondary Circuit Low P0232 – Fuel Pump Secondary Circuit High
Monitor Execution	Continuous
Monitor Sequence	None
Sensors OK	None
Typical Monitoring Duration	P0627, P0628, P0629 - 0.2 sec P0230, P0231, P0232, P062A – 0.5 sec

**Typical Fuel Low Pressure Lift Pump Monitor Malfunction Thresholds:**

P0627 – Lift pump NOT energized and the voltage from the lift pump control chip is between 2.8 – 4.8V (normal operation: 5V secondary voltage supply)

P0628 – Lift pump NOT energized and the voltage from the lift pump control chip is less than 2.8V (normal operation: 5V secondary voltage supply)

P0629 – Lift pump energized and the current to the lift pump exceeds 3.7A (normal operation: 2.2A maximum)

P062A – If the airbag deployment module sends a deployment signal and the fuel pump shows as energized via the fuel pump monitor signal or the status of the energizing request to the fuel pump and the monitoring signal from the fuel pump does not match (6.7L) or if the frequency of the signal to the lift pump is outside the range 0.8 Hz to 1.1 Hz (3.2L)

P0230 – If the lift pump duty cycle is outside the range 18-22%, this DTC is set.

P0231 – If the lift pump duty cycle is <5%, this DTC is set.

P0232 – If the lift pump duty cycle is >95%, this DTC is set.

**Fuel Injector Driver Circuit Monitor Operation:**

DTCs	P062D - Fuel Injector Driver Circuit Performance Bank 1 P062E - Fuel Injector Driver Circuit Performance Bank 2 P1291 - Injector High Side Short To GND Or VBATT (Bank 1) P1292 - Injector High Side Short To GND Or VBATT (Bank 2) P1295 – Injector Multiple Faults (Bank 1)
Monitor Execution	Continuous
Monitor Sequence	None
Sensors OK	None
Typical Monitoring Duration	P062D, P062E – 0.5 seconds P1291, P1292, P1295 – 0.2 seconds

**Typical Fuel Injector Driver Circuit Malfunction Thresholds:**

P062D, P062E – Failure of injector driver of bank detected by IC Internal logic  
P1291, P1292 – Short to ground or battery of bank detected by IC internal logic  
P1295 – One or more short to ground or battery faults detected (3.2L)

## Injection Circuits Monitor Operation:

DTCs	<p> P0201 - Injector Circuit / Open - Cylinder 1  P0202 - Injector Circuit / Open - Cylinder 2  P0203 - Injector Circuit / Open - Cylinder 3  P0204 - Injector Circuit / Open - Cylinder 4  P0205 - Injector Circuit / Open - Cylinder 5  P0206 - Injector Circuit / Open - Cylinder 6  P0207 - Injector Circuit / Open - Cylinder 7  P0208 - Injector Circuit / Open - Cylinder 8  P02EE – Cylinder 1 Injector Circuit Range/Performance  P02EF – Cylinder 2 Injector Circuit Range/Performance  P02F0 – Cylinder 3 Injector Circuit Range/Performance  P02F1 – Cylinder 4 Injector Circuit Range/Performance  P02F2 – Cylinder 5 Injector Circuit Range/Performance  P02F3 – Cylinder 6 Injector Circuit Range/Performance  P02F4 – Cylinder 7 Injector Circuit Range/Performance  P02F5 – Cylinder 8 Injector Circuit Range/Performance  P1201 – Cylinder #1 Injector Circuit Open/Shorted  P1202 – Cylinder #2 Injector Circuit Open/Shorted  P1203 – Cylinder #3 Injector Circuit Open/Shorted  P1204 – Cylinder #4 Injector Circuit Open/Shorted  P1205 – Cylinder #5 Injector Circuit Open/Shorted  P1206 – Cylinder #6 Injector Circuit Open/Shorted  P1207 – Cylinder #7 Injector Circuit Open/Shorted  P1208 – Cylinder #8 Injector Circuit Open/Shorted  P1261 – Cylinder #1 High To Low Side Short  P1262 – Cylinder #2 High To Low Side Short  P1263 – Cylinder #3 High To Low Side Short  P1264 – Cylinder #4 High To Low Side Short  P1265 – Cylinder #5 High To Low Side Short  P1266 – Cylinder #6 High To Low Side Short  P1267 – Cylinder #7 High To Low Side Short  P1268 – Cylinder #8 High To Low Side Short  P0261 – Cylinder 1 Injector "A" Circuit Low  P0262 – Cylinder 1 Injector "A" Circuit High  P0264 – Cylinder 2 Injector "A" Circuit Low  P0265 – Cylinder 2 Injector "A" Circuit High  P0267 – Cylinder 3 Injector "A" Circuit Low  P0268 – Cylinder 3 Injector "A" Circuit High  P0270 – Cylinder 4 Injector "A" Circuit Low  P0271 – Cylinder 4 Injector "A" Circuit High  P0273 – Cylinder 5 Injector "A" Circuit Low  P0274 – Cylinder 5 Injector "A" Circuit High  P126A – Cylinder 1 Injector Input Circuit  P126B – Cylinder 2 Injector Input Circuit  P126C – Cylinder 3 Injector Input Circuit  P126D – Cylinder 4 Injector Input Circuit  P126E – Cylinder 5 Injector Input Circuit </p>
Monitor Execution	Continuous
Monitor Sequence	None
Sensors OK	None
Typical Monitoring Duration	P0201 – P0208 – 0.3 seconds, P02EE – P2F5 – 0.3 seconds. P1201 – P1208 – 0.3 seconds, P1261 – P1268 – 0.3 seconds. P126A – P126E – 5 seconds

**Typical Injection Circuits Malfunction Thresholds:**

P0201 – P0208 – Injector open circuit detected by IC internal logic  
 P02EE – P02F5 – Implausible injector response detected by IC internal logic  
 P1201 – P1208 – Injector short circuit detected by IC internal logic  
 P1261 – P1268 – Injector high side to low side short circuit detected by IC internal logic  
 P0261 – P0273 (Low): IC internal control > 10 mJ  
 P0262 – P0274 (High): IC internal control < -10 mJ  
 P126A – P126E: voltage is not within 210 and 240 v

**Injector Code Missing/Invalid:****Injector Code Monitor Operation:**

DTCs	P268C – Cylinder 1 Injector Data Incompatible P268D – Cylinder 2 Injector Data Incompatible P268E – Cylinder 3 Injector Data Incompatible P268F – Cylinder 4 Injector Data Incompatible P2690 – Cylinder 5 Injector Data Incompatible P2691 – Cylinder 6 Injector Data Incompatible P2692 – Cylinder 7 Injector Data Incompatible P2693 – Cylinder 8 Injector Data Incompatible
Monitor Execution	Continuous
Monitor Sequence	None
Sensors OK	None
Typical Monitoring Duration	0.5 seconds

**Typical Injector Code Monitor Malfunction Thresholds:**

P268C – P2693: Each injector has a code stored in EEPROM that provides information to the ECU about deviations of that injector from a theoretical average injector. If the injector code is missing or invalid, a DTC is set.

## Fuel system pressure control:

### Fuel Rail Pressure Monitors:

The pressure in the fuel rail is controlled by a closed-loop control strategy that is always active during vehicle operation. Two controllers may be used to control the rail pressure: the Pressure Control Valve and the Volume Control Valve. The Pressure Control Valve is used to control pressure at engine start and when fuel temperature is low. The Volume Control Valve is used to control fuel pressure under most other conditions. A third operation mode allows fuel rail pressure to be controlled by a combination of the Pressure Control Valve and Volume Control Valve; this mode is typically used to transition from control by one device to the other and in regimes where low fuel volume is required.

The fuel rail pressure is controlled either with the Pressure Control Valve, the Volume Control Valve, or both, depending upon engine operation condition. The high and low Fuel Rail Pressure Monitors detect when there is an excessive deviation from the desired fuel pressure when the controller has reached a control limit or when the minimum or maximum allowable rail pressures are exceeded.

Fuel Rail Pressure ( FRP ) Monitor Operation:	
DTCs	P0087 - Fuel Rail/System Pressure - Too Low P0088 - Fuel Rail/System Pressure – Too High P0093 – Fuel System Leak Detected – Large Leak
Monitor Execution	Continuous
Monitor Sequence	None
Sensors OK	FRP (P0191, P0192, P0193)
Typical Monitoring Duration	P0087, P0088 – 1.4 sec P0093 – 2 sec

Typical Fuel Rail Pressure Monitor Malfunction Thresholds:
P0087: If the commanded rail pressure exceeds the measured rail pressure by 250 bar for 1.4 sec or if the measured rail pressure drops below 140 bar for 0.3 sec
P0088: If the measured rail pressure exceeds the commanded rail pressure by 250 bar for 1.4 sec or if the measured rail pressure exceeds 2150 bar for 0.3 sec
P0093: If the set point needed for the volume control valve to maintain desired rail pressure exceeds 13,500 mm <sup>3</sup> /sec at idle or if the set point needed for the volume control valve to maintain desired rail pressure is 40% greater than the volume control valve set point as calculated from the requested injection quantity when not at idle



**Low Fuel Rail Pressure Switch Monitor Operation:**

DTCs	P2539 - Low Pressure Fuel System Sensor Circuit P008A - Low Pressure Fuel System Pressure - Too Low
Monitor Execution	Continuous
Monitor Sequence	None
Sensors OK	none
Typical Monitoring Duration	P2539 – 50 ms P008A – 5 sec

**Low Fuel Rail Pressure Switch Monitor Entry Conditions:**

Entry condition	Minimum	Maximum
Fuel Temperature	-40 deg C	
Fuel in tank		10 liter
Engine coolant temperature	-40 deg C	
Airbag	Not deployed	
Battery	9 v	
Duration time since Low Fuel Rail Pressure indicated	12 sec	

**Typical Fuel Rail Pressure Monitor Malfunction Thresholds:**

P2539: If fuel pressure switch is on, code is set.

P008A: If fuel filter pressure switch switching frequency > 10, code is set

## Injection Timing / Injection quantity

### Fuel Balancing Control:

Fuel Balancing Control is an algorithm designed to reduce differences in injected fuel quantity from cylinder to cylinder. The increase in crankshaft speed due to individual cylinder combustion events is measured. The amount of fuel injected to each cylinder is then adjusted up or down to minimize the difference in increase in crankshaft speed from cylinder to cylinder. The total amount of fuel injected among all cylinders remains constant. The concept is shown in the graphic below.

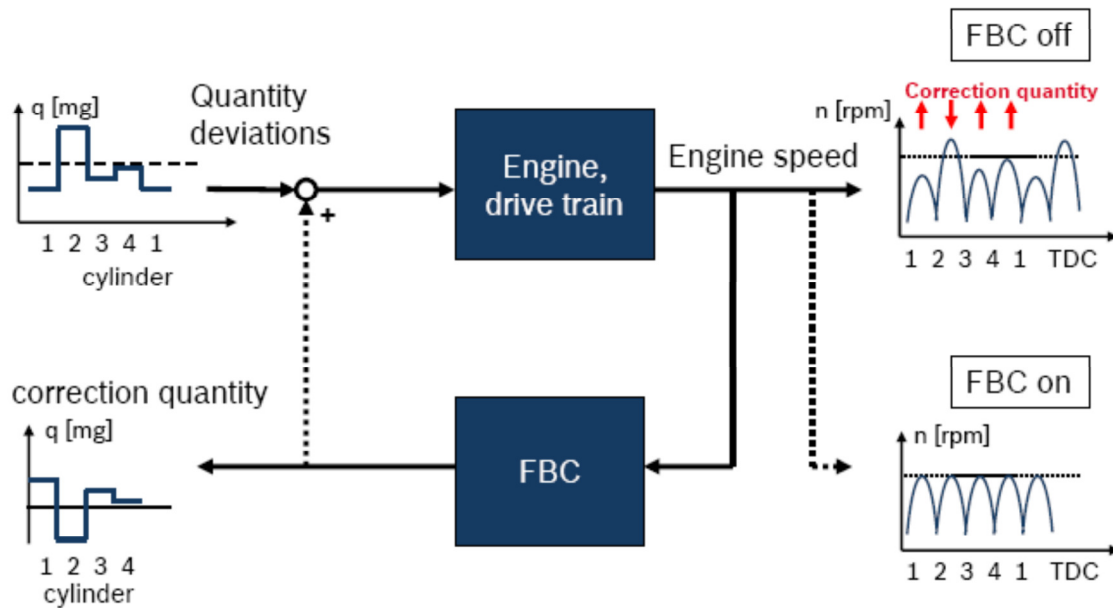

FBC operates in closed-loop control in an engine speed range of 500-3000 rpm, and a commanded injection quantity of 3.5 – 90 mg/stroke. The maximum allowed correction in fuel quantity for an individual cylinder is given by the following table.

Fuel Balancing Control (FBC) Control Limits:			
Injection quantity requested before FBC correction (mg/stroke)			
Maximum allowable FBC correction (mg/stroke):	3.5	7.5	15
	4	7	14

**Fuel Balancing Control (FBC) Monitor Operation:**

DTCs	P0263 – Cylinder #1 Contribution/Balance P0266 – Cylinder #2 Contribution/Balance P0269 – Cylinder #3 Contribution/Balance P0272 – Cylinder #4 Contribution/Balance P0275 – Cylinder #5 Contribution/Balance P0278 – Cylinder #6 Contribution/Balance P0281 – Cylinder #7 Contribution/Balance P0284 – Cylinder #8 Contribution/Balance P029A - Cylinder 1 – Fuel Trim at Max Limit P029B - Cylinder 1 – Fuel Trim at Min Limit P029E - Cylinder 2 – Fuel Trim at Max Limit P029F - Cylinder 2 – Fuel Trim at Min Limit P02A2 - Cylinder 3 – Fuel Trim at Max Limit P02A3 - Cylinder 3 – Fuel Trim at Min Limit P02A6 - Cylinder 4 – Fuel Trim at Max Limit P02A7 - Cylinder 4 – Fuel Trim at Min Limit P02AA - Cylinder 5 – Fuel Trim at Max Limit P02AB - Cylinder 5 – Fuel Trim at Min Limit
Monitor Execution	continuous
Monitor Sequence	None
Sensors OK	CKP (P0335, P0336)
Typical Monitoring Duration	7.5 sec

**Typical Fuel Balancing Control (FBC) Monitor Entry Conditions:**

Entry condition	Minimum	Maximum
Engine speed	500 rpm	3000 rpm
Injection quantity	3.5 mg/stroke	90 mg/stroke
Not In Regeneration		
FBC wheel learn complete		

**Typical Fuel Balancing Control (FBC) Monitor Malfunction Thresholds:**

P0266 – P0284: If the current correction for the injector exceeds 90% of the allowable correction for current operation conditions, the code is set.

P029A – P02AB: If absolute value of cylinder balance limit exceeds 0.1001 then code is set.

## Fuel Mass Observer (Global Fuel Bias):

Fuel Mass Observer (FMO) is an algorithm used to detect deviations in performance of all injectors from nominal. The oxygen percentage as measured by the tailpipe oxygen sensor is compared to a modeled oxygen percentage based upon current fuel, boost, and EGR settings. Deviation between the observed and modeled oxygen percentage is expressed in terms of the error in fueling required to explain the deviation. This calculated error in fueling is then divided by the current requested fueling level to generate a ratio of percentage error in fueling. This fueling ratio is then filtered over time. If the filtered error in fueling ratio exceeds minimum or maximum limits, then a code is set.

Fuel Mass Observer (FMO) Monitor Operation:	
DTCs	P0170 – Fuel Trim (Bank 1)
Monitor Execution	Continuous
Monitor Sequence	None
Sensors OK	
Typical Monitoring Duration	P0170 - 45 sec

Typical Fuel Mass Observer (FMO) Monitor Entry Conditions:		
Entry condition	Minimum	Maximum
Engine speed	1000 rpm	3000 rpm
Fuel injection quantity	20 mg/stroke	80 mg/stroke
Ambient pressure	700 hPa	
System voltage	9 V	
Ambient temperature	-5 C	
Tailpipe oxygen sensor status	Ready	
Post injection	Not occurring	

Typical Fuel Mass Observer (FMO) Monitor Malfunction Thresholds:
P0170 : if the absolute value of the filtered ratio of error in fueling exceeds 0.19, this code is set.

## Feedback control:

## Zero Fuel Calibration:

Zero Fuel Calibration (ZFC) is an algorithm used to compensate for deviations in individual injector performance from nominal. In an overrun/decel fuel shut-off condition, fuel rail pressure is set to 300 bar and small injections are made from a single injector. The observed acceleration in crankshaft speed is detected and a regression line generated to predict the fueling required to achieve the expected acceleration. If the calculated fueling required to generate the expected acceleration in crankshaft speed falls outside the allowable control limits for the system, an addition routine is called to very precisely learn the adjustment to injector energizing time required to achieve expected acceleration. This information is then used to adjust all pilot injections on that injector to ensure correct fuel delivery. If the absolute energizing time observed for the test injection to yield the expected acceleration exceeds minimum or maximum limits, a code is set.

Zero Fuel Calibration (ZFC) Monitor Operation:	
DTCs	P02CC – Cylinder 1 Fuel Injector Offset Learning at Min Limit P02CD – Cylinder 1 Fuel Injector Offset Learning at Max Limit P02CE – Cylinder 2 Fuel Injector Offset Learning at Min Limit P02CF – Cylinder 2 Fuel Injector Offset Learning at Max Limit P02D0 – Cylinder 3 Fuel Injector Offset Learning at Min Limit P02D1 – Cylinder 3 Fuel Injector Offset Learning at Max Limit P02D2 – Cylinder 4 Fuel Injector Offset Learning at Min Limit P02D3 – Cylinder 4 Fuel Injector Offset Learning at Max Limit P02D4 – Cylinder 5 Fuel Injector Offset Learning at Min Limit P02D5 – Cylinder 5 Fuel Injector Offset Learning at Max Limit P02D6 – Cylinder 6 Fuel Injector Offset Learning at Min Limit P02D7 – Cylinder 6 Fuel Injector Offset Learning at Max Limit P02D8 – Cylinder 7 Fuel Injector Offset Learning at Min Limit P02D9 – Cylinder 7 Fuel Injector Offset Learning at Max Limit P02DA – Cylinder 8 Fuel Injector Offset Learning at Min Limit P02DB – Cylinder 8 Fuel Injector Offset Learning at Max Limit
Monitor Execution	Continuous
Monitor Sequence	None
Sensors OK	
Typical Monitoring Duration	all DTCs 30 sec

**Typical Zero Fuel Calibration (ZFC) Monitor Entry Conditions:**

Entry condition	Minimum	Maximum
P02CC, P02CD, P02CE, P02CF, P02D0, P02D1, P02D2, P02D3, P02D4, P02D5, P02D6, P02D7, P02D8, P02D9, P02DA, P02DB:		
Intake air temperature	0 deg C	
Fuel temperature	10 deg C	75 deg C
Engine coolant temperature	50 deg C	
System voltage	10 V	
Time in overrun/decel fuel shut-off		30 sec
Engine speed	890 rpm	1610 rpm
Boost pressure	750 mbar	
Accelerator pedal		2 %
Transmission gear (no gear change)	4 th	6 th
Torque converter locked		
Fuel Balance Control wheel learn complete		
Note: these are the entry conditions for the base function. The monitor runs whenever the base function runs.		

**Typical Zero Fuel Calibration (ZFC) Monitor Malfunction Thresholds:**

P02CC, P02CE, P02D0, P02D2, P02D4, P02D6, P02D8, P02DA:

If the observed energizing time for the test injection is 156 us or more lower than the target 430 us energizing time for the given injector, the code is set.

P02CD, P02CF, P02D1, P02D3, P02D5, P02D7, P02D9, P02DB:

If the observed energizing time for the test injection is 254 us or more higher than the target 430 us energizing time for the given injector, the code is set.

### Nominal Voltage Calibration:

Nominal Voltage Calibration (NVC) is a series of closed-loop controllers on the charge/discharge profile of fuel injectors during an injection event. NVC is designed to compensate for changes due to aging of the piezo stack and hydraulic control elements within individual injectors and of the injector charging circuitry to maintain consistent operation of these components over the life of the injector. The injector charge/discharge profile is shown in the figure below.

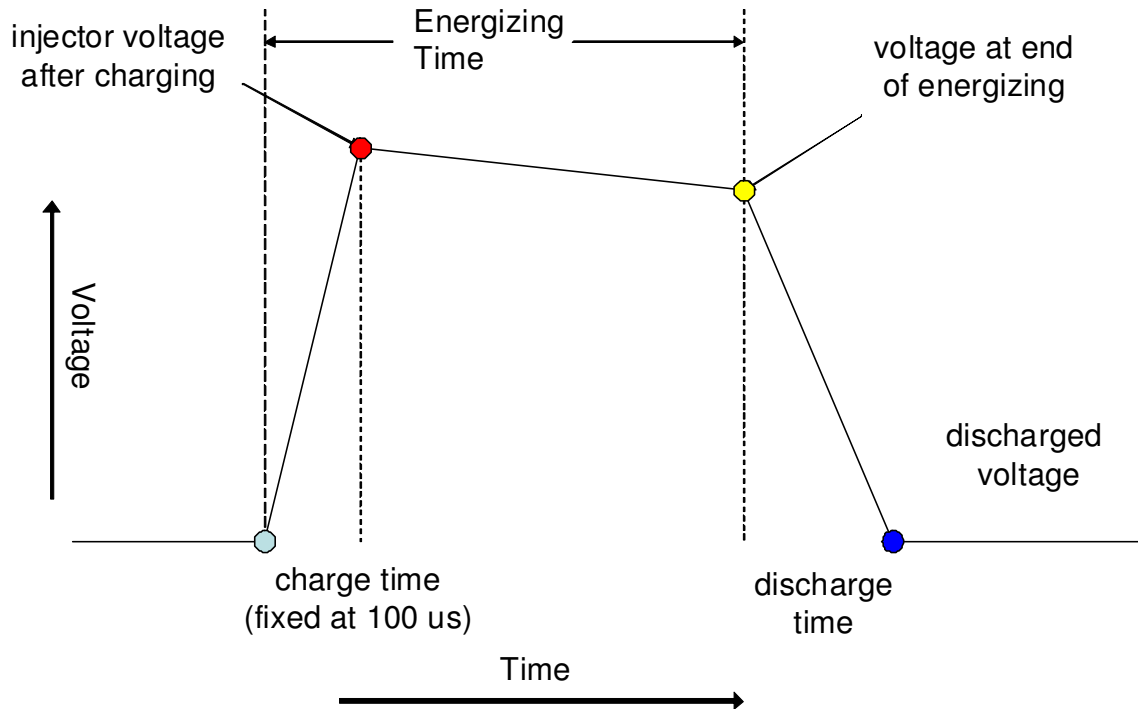

Nominal Voltage Calibration (NVC) Monitor Operation:	
DTCs	P1551 – Cylinder 1 Injector Circuit Range/Performance P1552 – Cylinder 2 Injector Circuit Range/Performance P1553 – Cylinder 3 Injector Circuit Range/Performance P1554 – Cylinder 4 Injector Circuit Range/Performance P1555 – Cylinder 5 Injector Circuit Range/Performance P1556 – Cylinder 6 Injector Circuit Range/Performance P1557 – Cylinder 7 Injector Circuit Range/Performance P1558 – Cylinder 8 Injector Circuit Range/Performance
Monitor Execution	continuous
Monitor Sequence	None
Sensors OK	Injector open circuit (P0201-0208), Injector performance (P02EE-02F5), Injector short circuit (P1201-1208), Injector high to low short (P1261-1268), ECT (P0117, P0118), RPS (P0191, P0192, P0193, P228E, P228F)
Typical Monitoring Duration	2 sec (set point voltage), 90 sec (other two tests)

**Typical Nominal Voltage Calibration (NVC) Monitor Entry Conditions:**

Entry condition	Minimum	Maximum
Rail pressure	1200 bar	1600 bar
Engine coolant temperature	70 deg C	100 deg C
Injection duration	300 us	
Single pilot-main injection profile		

**Typical Nominal Voltage Calibration (NVC) Monitor Malfunction Thresholds:**

If the set point voltage at end of energizing (yellow dot in figure) exceeds the allowable voltage given in the chart below for the current rail pressure set point or if there exists a persistent deviation between set and measured discharge time (yellow dot to blue dot in figure) or if there exists a persistent deviation between the set and measured voltage at end of energizing (yellow dot in figure)

**Maximum Allowable Voltage At End of Energizing :**

Rail pressure (bar)	300	800	1200	2000
Maximum allowed voltage (V)	89	91	93	108



## EXHAUST GAS SENSOR MONITOR

### Air-Fuel Ratio Sensors: Feedgas NOx Sensor Control Module

The NOx controller module is mounted to the vehicle frame under the body. It is used to control the feed gas NOx sensor mounted in diesel after-treatment exhaust system upstream of the SCR and DPF on a Chassis Certified Vehicle and upstream of the SCR only on a Dynamometer Certified Vehicle. It communicates to the ECU via HSCAN to report NOx concentrations or OBDII errors.



The controller module consists of RAM, ROM, EEPROM, Ip1 circuit, Ip2 circuit, R<sub>pvs</sub> circuit, heater driver, microprocessor, and temperature sensor. The RAM temporarily stores information obtained from the sensing element during operation. The ROM and EEPROM store sensor and controller module calibration coefficients obtained during the manufacturing process. The Ip2 circuit adjusts the pumping current in the sensing element's Ip2 circuit for NOx detection. The Ip2 circuit consists of 2 bands: a wide range and a narrow range. The R<sub>pvs</sub> circuit is a measurement of the resistance of the V<sub>s</sub> cell of the sensor element. This measurement is used to estimate the temperature of the sensing element. The heater driver supplies a PWM voltage to the heater portion of the sensing element to maintain the element's target operational temperature. PID feedback from R<sub>pvs</sub> is used to control and maintain the element temperature. The microprocessor processes all of the inputs from the sensing element and outputs to the CAN circuit. The temperature sensor in the controller module is used for compensating the temperature dependency of circuit components and for OBD rationality checks.

The NOx controller module interfaces with the vehicle via a power source, signal ground, power ground, CAN-H and CAN-L. The compensated NOx concentration; R<sub>pvs</sub>, pressure compensation factors, sensor/module OBD (including monitor completion flags), module temperature, software ID, CALID, and CVN are communicated via HSCAN to the vehicle PCM.

<b>NOx Controller Module Malfunctions</b>	
DTCs	P06EA NOx Sensor Processor Performance (Bank 1 Sensor 1) U05A1 NOx Sensor "A" Received Invalid Data From ECM/PCM P225A NOx Sensor Calibration Memory (Bank 1 Sensor 1)
Monitor execution	Continuous
Monitor Sequence	Ip2-N and Ip2-W range rationality – $50\text{ppm} < [\text{NOx}] < 100\text{ppm}$
Sensors OK	not applicable
Monitoring Duration	5 seconds to register a malfunction

<b>Typical NOx Controller Malfunction Thresholds</b>	
P06EA	RAM failure ROM CRC check error EEPROM CRC check error Ip1 out of range – $\text{Ip1(VIP2.1)} < 1.8\text{V}$ , $\text{Ip1(VIP2.1)} > 2.2\text{V}$ , $\text{Ip1(VIP2.2)} < 0.2\text{V}$ , or $\text{Ip1(VIP2.2)} > 0.6\text{V}$ Ip2-W out of range – $\text{Vs+} \geq 5.35\text{V}$ and $\text{Ip2-W} > 4.8\text{V}$ Ip2-N out of range – $\text{Vs+} \geq 5.35\text{V}$ and $\text{Ip2-N} < 0.2\text{V}$ Ip2-N and Ip2-W range rationality – Integral value of differential between Ip2-N & Ip2-W $\geq 250\text{ppm}$ Vp2 circuit failure – $\text{Vp2} < 250\text{mV}$ or $\text{Vp2} > 650\text{mV}$ Rpvs short to ground – $\text{Rpvs} < 0.2\text{V}$ Temperature sensor short to battery – $\text{Temp} > 4.5\text{V}$ Temperature sensor short to ground – $\text{Temp} < 0.45\text{V}$ Temperature sensor open – $0.45\text{V} \leq \text{Temp} < 0.48\text{V}$  NOx Module temperature within 40 deg. C of Exhaust Temperature Sensor on Cold Start
U05A1	Erroneous Signal (Dew point reached with ignition off, etc.) Timeout (>1 second before message received)
P225A	Memory does not pass CRC check

The NOx sensor is primarily used to sense NOx concentrations in diesel exhaust gas. The sensor is mounted in a vehicle's exhaust pipe, perpendicular to exhaust gas flow. The sensor is typically mounted, in an aftertreatment-equipped diesel exhaust system, upstream of the SCR and DPF on a Chassis Certified Vehicle and upstream of the SCR only on a Dynamometer Certified Vehicle. The sensor interfaces to a NOx controller module that controls the sensor element's sense circuit and heater.

The Ip2 (NOx concentration) measurement takes place in a 2<sup>nd</sup> measurement chamber. Exhaust gas passes from the 1<sup>st</sup> measurement chamber through a 2<sup>nd</sup> diffusion barrier into the 2<sup>nd</sup> measurement chamber. The NOx present in the 2<sup>nd</sup> measurement chamber is dissociated into N2 and O2. The excess O2 is pumped out of the 2<sup>nd</sup> measurement chamber by the pumping current, Ip2. Ip2 is proportional to the NOx concentration in the measured gas.

The NOx sensor is equipped with a memory component which stores unique sensor characteristics used to compensate for part-to-part variation of the element during the manufacturing process. The memory stores Ip1 and Ip2 gains/offsets for each individual sensor.

The NOx sensor interfaces the NOx controller module with the following:

- Ip2** – pumping current for pumping out dissociated O2 from 2<sup>nd</sup> chamber
- COM** – virtual ground for Vs, Ip1, and Ip2 circuits
- Vs** – Nernst cell voltage, 425mV from COM. Also carries current for pumped reference.
- TM** – Touch memory which stores Ip1 and Ip2 gain/offset.
- TM GND** – Ground for touch memory reading
- H+** – Heater voltage (High-side driver) – Duty cycle ON/OFF to control sensor temperature.
- H-** – Heater ground side

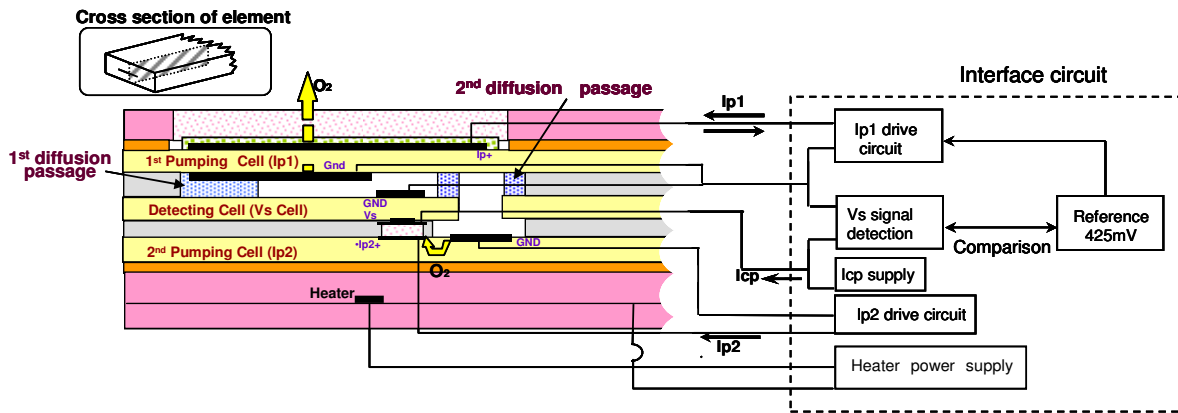

### IP2 Open (FLO) OBD Algorithm

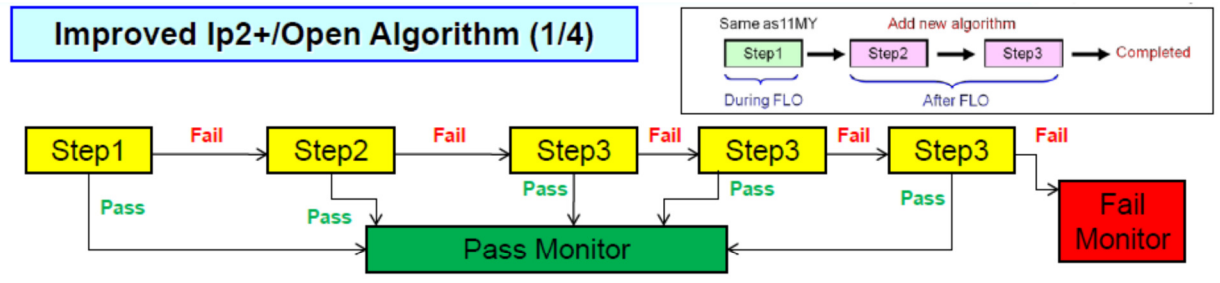

#### Step1 (Current algorithm)

- This algorithm runs during FLO by using constant current circuit.
- If Ip2 open occurs, Ip2 voltage sticks on 0V.
- Ip2 voltage is at 5V in no failure.

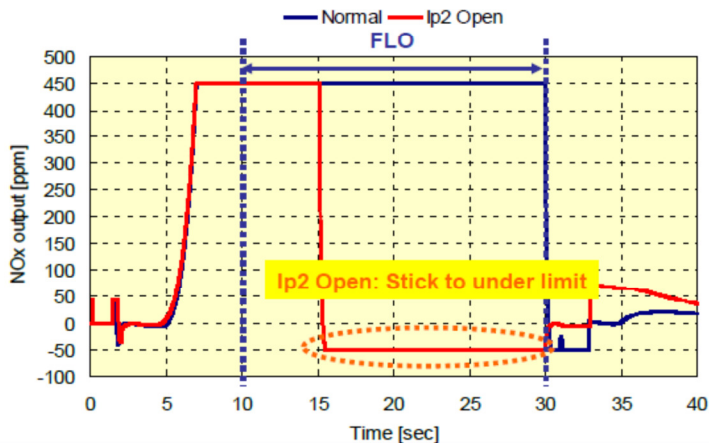

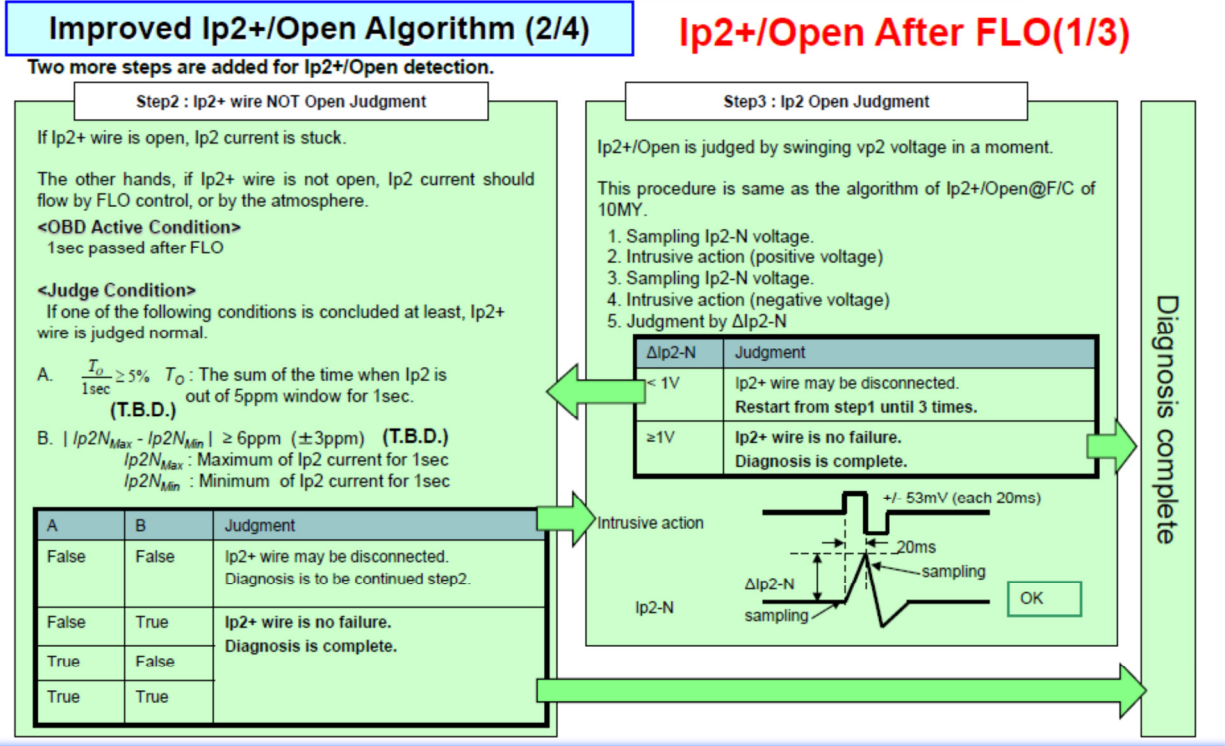

The Feed Gas Low NOx Plausibility Monitor runs once per drive cycle during an intrusive EGR shutoff, in which the calculated NOx value (using fuel quantity, temperature and ambient pressure) is then compared to the threshold.

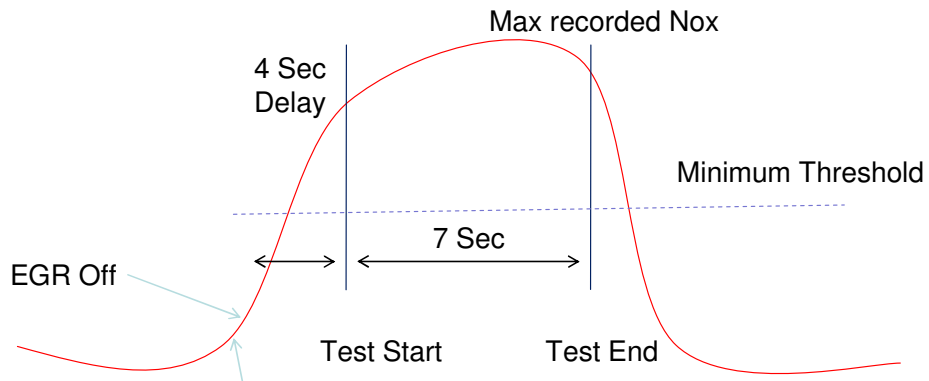

<b>FG NOx Plausibility Monitor</b>	
DTCs	P2201 - NOx Sensor Circuit Range/Performance (Bank 1 Sensor 1)
Monitor execution	Once a drive cycle
Monitor Sequence	When EGR is disabled at idle, for air mass adaptation, the monitor runs.
Sensors OK	NOx Sensor, EGR system
Monitoring Duration	11 seconds to register a malfunction

<b>Typical Nominal FG NOx Plausibility Monitor Entry Conditions:</b>		
Entry condition	Minimum	Maximum
Pedal Position		0%
Fuel	7 mg/stroke	15 mg/stroke
Engine Coolant	70C	
Fuel Cut Duration before test	1.5 sec.	

<b>Typical NOx Controller Malfunction Thresholds</b>
Measured maximum NOx is less than 50% of expected.

<b>NOx Sensor Malfunctions</b>	
DTCs	P2200 NOx Sensor Circuit (Bank 1 Sensor 1) P2201 NOx Sensor Circuit Range/Performance (Bank 1 Sensor 1) P220E NOx Sensor Heater Control Circuit Range/Performance (Bank 1 Sensor 1) P2209 NOx Sensor Heater Sense Circuit Range/Performance (Bank 1 Sensor 1) P220A NOx Sensor Supply Voltage Circuit (Bank 1 Sensor 1)
Monitor execution	continuous
Monitor Sequence	lp2 Open – O2 ≥ 5% or F/C > 3 seconds and O2 ≥ 19% lp2 Crack – F/C > 5 seconds and O2 ≥ 19%
Sensors OK	Not applicable
Monitoring Duration	

## Typical NOx Sensor Malfunctions Thresholds

P2200	<p>Vs, COM, Ip1 short to battery – ASIC Diag2=1 and Vs, COM, Ip1 <math>\geq</math> 9V                      Ip2 short to battery – Ip2 <math>\geq</math> 4.8V                      Vs, COM, Ip1 short to ground – ASIC Diag2=1 and Vs, COM, Ip1 <math>&lt;</math> 9V                      Ip2 short to ground – Ip2 <math>\leq</math> 2V                      Ip1 Open – Vs <math>\leq</math> 225mV, Vs <math>\geq</math> 625mV &amp; <math>-0.2\text{mA} \leq \text{Ip1} \leq 0.2\text{mA}</math>                      Vs Open – Vs <math>&gt;</math> 1.5V                      COM Open – RpvS <math>&gt;</math> RpvSA (target RpvS stored in sensor memory) or ASIC Diag1=1                      Ip2 Open – Ip2-W <math>\leq</math> 0.2V and Ip2-N <math>\leq</math> 0.2V                      Sensor Memory CRC check                      Vs/Ip1 Cell Crack – Ip1 <math>&gt;</math> 6.4mA                      Ip2 Cell Crack – Ip2-W <math>&gt;</math> 4.8V</p>
P2201	<p>NOx Sensor reading 50% Lower than expected (low threshold) during EGR Off                      NOx Negative Offset – NOx Sensor greater than <math>\sim -20</math> ppm offset                      NOx Positive Offset – NOx Sensor greater than <math>\sim 50</math> ppm offset</p>
P220E	<p>Heater control failure – RpvS <math>\geq</math> 0.2V and RpvS <math>&lt;</math> TRpvS - 30<math>\Omega</math> or RpvS <math>&gt;</math> TRpvS + 30<math>\Omega</math>                      Heater Open – Heater current <math>&lt;</math> 0.4A                      Heater short to battery – <math>\Delta</math> Heater Voltage <math>&gt;</math> 0.2V                      Heater short to ground – <math>\Delta</math> Heater Voltage <math>&gt;</math> 0.2V                      Heater performance failure – Heater current <math>\geq</math> 0.4A and Heater Resistance <math>\geq</math> 11<math>\Omega</math></p>
P2209	NOx Availability – $>$ 1 PL (Healing mode) per cycle or $>$ 9 sec of NOx not valid
P220A	Battery failure – Battery $>$ 17V or Battery $<$ 10V

## NOx Sensor Operation Modes

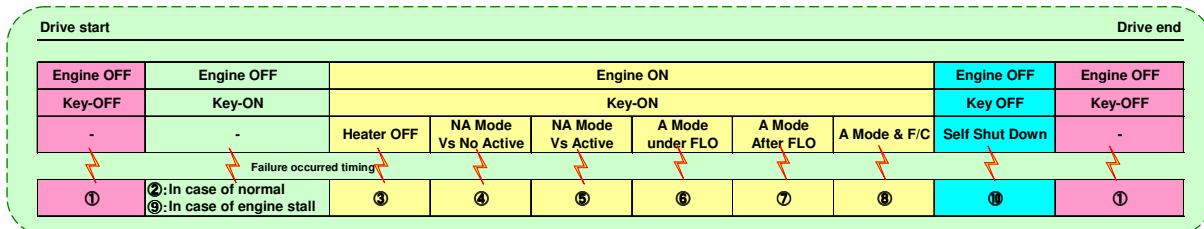

Mode 1 – No voltage supply to module or sensor. Non-operational.

Mode 2 – Voltage is supplied to module, yet voltage is not supplied to the sensor.

Mode 3 – Voltage is supplied to module, yet voltage is not supplied to the sensor. Dew-point waiting period.

Mode 4 – Voltage is supplied to the module and to the sensor. The Vs cell of the sensor is not active.

Mode 5 – Voltage is supplied to the module and to the sensor. The Vs cell of the sensor is active.

Mode 6 – Voltage is supplied to the module and to the sensor. Sensor is in fast light-off to quickly heat sensing element to operational temperature.

Mode 7 – Voltage is supplied to the module and to the sensor. The sensor has exited fast light-off and O2 and NOx will be available during this mode.

Mode 8 - Voltage is supplied to the module and to the sensor. The sensor has exited fast light-off and O2 and NOx will be available during this mode. During this mode a fuel cut condition is present, as communicated by the PCM.

Mode 9 - Voltage is supplied to module, yet voltage is not supplied to the sensor.

Mode 10 - No voltage supply to module or sensor. Non-operational.

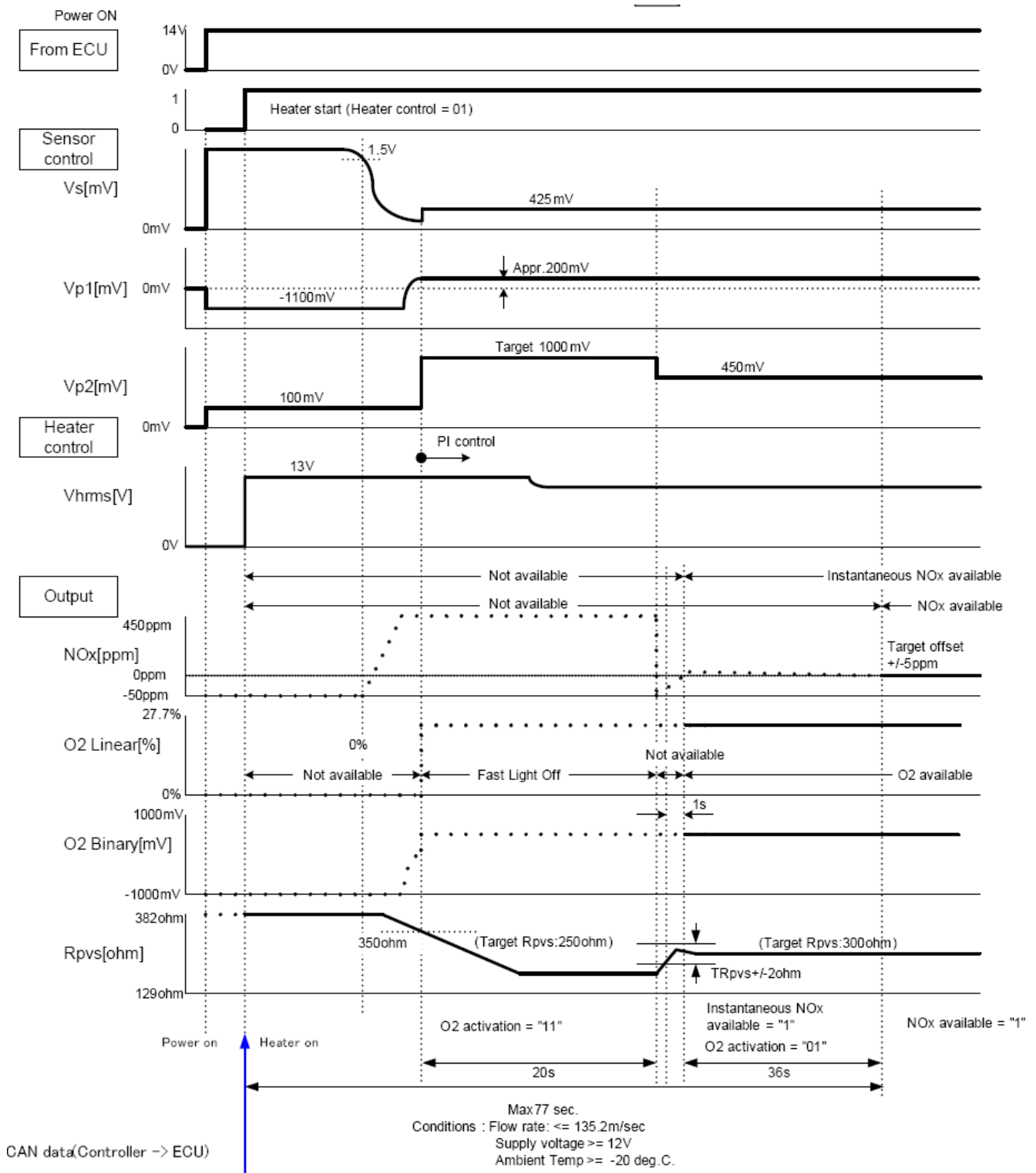

## Air-Fuel Ratio Sensors: Tailpipe NOx and O2 Sensor Control Module

The NOx controller module is mounted to the vehicle frame under the body. It is used to control the combination tailpipe NOx and O2 sensor mounted in diesel after-treatment exhaust system downstream of the SCR and DPF. It communicates to the ECU via HSCAN to report NOx and O2 concentrations or OBDII errors.

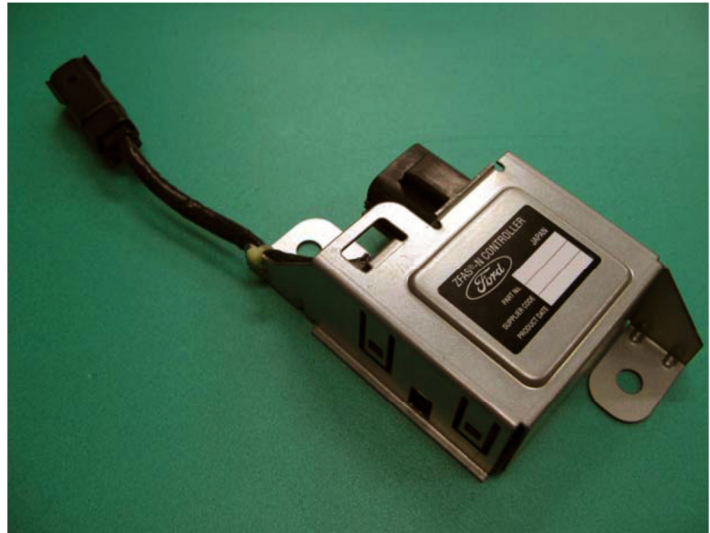

The controller module consists of RAM, ROM, EEPROM, Ip1 circuit, Ip2 circuit, R<sub>pvs</sub> circuit, heater driver, microprocessor, and temperature sensor. The RAM temporarily stores information obtained from the sensing element during operation. The ROM and EEPROM store sensor and controller module calibration coefficients obtained during the manufacturing process. The Ip1 circuit consists of an ASIC (like that of a UEGO ASIC) that adjusts pumping current in the sensing element's Ip1 circuit for O2 detection. The Ip2 circuit adjusts the pumping current in the sensing element's Ip2 circuit for NOx detection. The Ip2 circuit consists of 2 bands: a wide range and a narrow range. The R<sub>pvs</sub> circuit is a measurement of the resistance of the V<sub>s</sub> cell of the sensor element. This measurement is used to estimate the temperature of the sensing element. The heater driver supplies a PWM voltage to the heater portion of the sensing element to maintain the element's target operational temperature. PID feedback from R<sub>pvs</sub> is used to control and maintain the element temperature. The microprocessor processes all of the inputs from the sensing element and outputs to the CAN circuit. The temperature sensor in the controller module is used for compensating the temperature dependency of circuit components and for OBD rationality checks.

The NOx controller module interfaces with the vehicle via a power source, signal ground, power ground, CAN-H and CAN-L. The compensated O2 concentration compensated NOx concentration; R<sub>pvs</sub>, pressure compensation factors, sensor/module OBD (including monitor completion flags), module temperature, software ID, CALID, and CVN are communicated via HSCAN to the vehicle PCM.



NOx Controller Module Malfunctions	
DTCs	P06EB NOx Sensor Processor Performance (Bank 1 Sensor 2) U05A2 NOx Sensor "B" Received Invalid Data From ECM/PCM P225B NOx Sensor Calibration Memory (Bank 1 Sensor 2)
Monitor execution	Continuous
Monitor Sequence	Ip2-N and Ip2-W range rationality – $50\text{ppm} < [\text{NOx}] < 100\text{ppm}$
Sensors OK	not applicable
Monitoring Duration	5 seconds to register a malfunction

Typical NOx Controller Malfunction Thresholds	
P06EB	RAM failure ROM CRC check error EEPROM CRC check error Ip1 out of range – $\text{Ip1(VIP2.1)} < 1.8\text{V}$ , $\text{Ip1(VIP2.1)} > 2.2\text{V}$ , $\text{Ip1(VIP2.2)} < 0.2\text{V}$ , or $\text{Ip1(VIP2.2)} > 0.6\text{V}$ Ip2-W out of range – $\text{Vs+} \geq 5.35\text{V}$ and $\text{Ip2-W} > 4.8\text{V}$ Ip2-N out of range – $\text{Vs+} \geq 5.35\text{V}$ and $\text{Ip2-N} < 0.2\text{V}$ Ip2-N and Ip2-W range rationality – Integral value of differential between Ip2-N & Ip2-W $\geq 250\text{ppm}$ Vp2 circuit failure – $\text{Vp2} < 250\text{mV}$ or $\text{Vp2} > 650\text{mV}$ Rpvs short to ground – $\text{Rpvs} < 0.2\text{V}$ Temperature sensor short to battery – $\text{Temp} > 4.5\text{V}$ Temperature sensor short to ground – $\text{Temp} < 0.45\text{V}$ Temperature sensor open – $0.45\text{V} \leq \text{Temp} < 0.48\text{V}$  NOx Module temperature within 40 deg. C of Exhaust Temperature Sensor on Cold Start
U05A2	Erroneous Signal (Dew point reached with ignition off, etc.) Timeout (>1 second before message received)
P225B	Memory does not pass CRC check

The NOx sensor is primarily used to sense O2 and NOx concentrations in diesel exhaust gas. The sensor is mounted in a vehicle's tailpipe, perpendicular to exhaust gas flow. The sensor is typically mounted downstream of an SCR and DPF in an aftertreatment-equipped diesel exhaust system. The sensor interfaces to a NOx controller module that controls the sensor element's sense circuit and heater.

The NOx Sensor operates similarly to a UEGO sensor for measuring Ip1 (O2 concentration). Exhaust gas enters through a diffusion barrier into the 1st measurement chamber. The sensor infers an air fuel ratio relative to the stoichiometric (chemically balanced) air fuel ratio by balancing the amount of oxygen pumped in or out of the 1st measurement chamber. As the exhaust gasses get richer or leaner, the amount of oxygen that must be pumped in or out to maintain a stoichiometric air fuel ratio in the 1st measurement chamber varies in proportion to the air fuel ratio. By measuring the current required to pump the oxygen in or out, the O2 concentration can be estimated.

The Ip2 (NOx concentration) measurement takes place in a 2nd measurement chamber. Exhaust gas passes from the 1st measurement chamber through a 2nd diffusion barrier into the 2nd measurement chamber. The NOx present in the 2nd measurement chamber is dissociated into N2 and O2. The excess O2 is pumped out of the 2nd measurement chamber by the pumping current, Ip2. Ip2 is proportional to the NOx concentration in the measured gas.

The NOx sensor is equipped with a memory component which stores unique sensor characteristics used to compensate for part-to-part variation of the element during the manufacturing process. The memory stores Ip1 and Ip2 gains/offsets for each individual sensor.

The NOx sensor interfaces the NOx controller module with the following:

- Ip1** – pumping current for maintaining the A/F ratio in the 1<sup>st</sup> chamber
- Ip2** – pumping current for pumping out dissociated O2 from 2<sup>nd</sup> chamber
- COM** – virtual ground for Vs, Ip1, and Ip2 circuits
- Vs** – Nernst cell voltage, 425mV from COM. Also carries current for pumped reference.
- TM** – Touch memory which stores Ip1 and Ip2 gain/offset.
- TM GND** – Ground for touch memory reading
- H+** – Heater voltage (High-side driver) – Duty cycle ON/OFF to control sensor temperature.
- H-** – Heater ground side

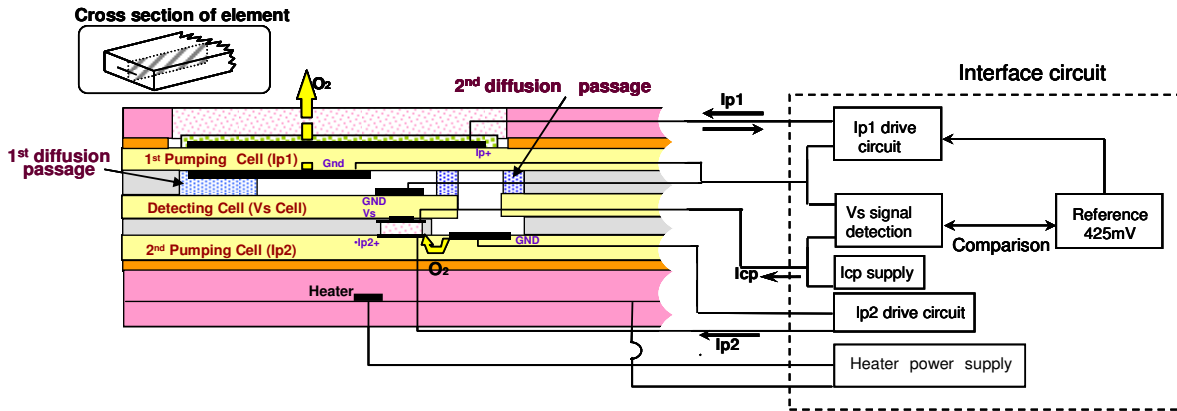

IP2 Open (FLO) OBD Algorithm

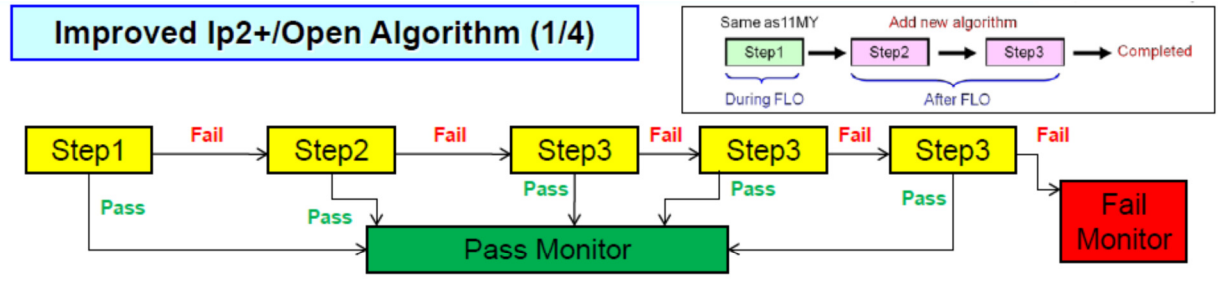

**Step1 (Current algorithm)**

- This algorithm runs during FLO by using constant current circuit.
- If Ip2 open occurs, Ip2 voltage sticks on 0V.
- Ip2 voltage is at 5V in no failure.

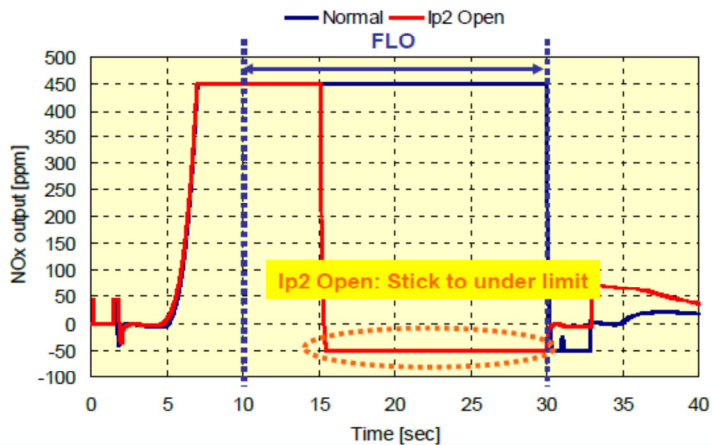

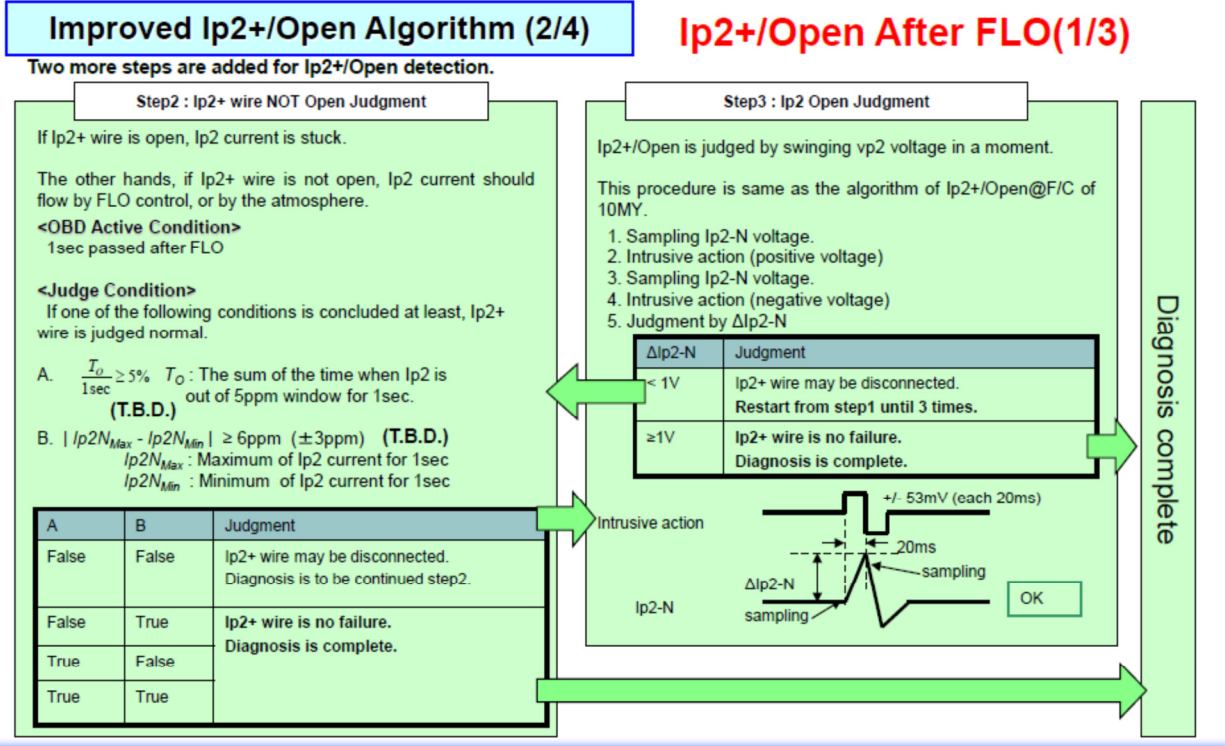

NOx – O2 Sensor Malfunctions	
DTCs	P0139 O2 Sensor Circuit Slow Response (Bank 1 Sensor 2) P0140 O2 Sensor Circuit No Activity Detected (Bank 1 Sensor 2) P2A01 O2 Sensor Circuit Range/Performance (Bank 1 Sensor 2) P229E NOx Sensor Circuit (Bank 1 Sensor 2) P229F NOx Sensor Circuit Range/Performance (Bank 1 Sensor 2) P220F NOx Sensor Heater Control Circuit Range/Performance (Bank 1 Sensor 2) P22A7 NOx Sensor Heater Sense Circuit Range/Performance (Bank 1 Sensor 2) P220B NOx Sensor Supply Voltage Circuit (Bank 1 Sensor 2)
Monitor execution	Continuous
Monitor Sequence	Ip2 Open – O2 $\geq 5\%$ or F/C > 3 seconds and O2 $\geq 19\%$ Ip2 Crack – F/C > 5 seconds and O2 $\geq 19\%$
Sensors OK	not applicable

## Typical NOx – O2 Sensor Malfunctions Thresholds

P0139 As shown in figure below, during a transition from load to overrun/decel fuel shutoff, one of the following occurs:

The time for the observed O2 percentage to increase from the value under load by 30% of (21%-O2 percentage under load) exceeds 6 seconds

OR

The time for the observed O2 percentage to increase from the value under load + 30% of the difference to the value under load + 60% of the difference exceeds 5 seconds

OR

The time for the observed O2 percentage to increase from the value under load to the value under load + 60% of the difference exceeds 11 seconds. (Used to detect completely inert sensors.)

(monitor operates when the vehicle is not undergoing particulate filter regeneration)

P0140 If there is no available O2 signal at 300 seconds after the sensor has achieved operating temperature

P2A01 A calculated oxygen concentration is derived from fuel, boost, and EGR. Observed oxygen concentration is evaluated within two speed/load/air mass ranges. Code is set if observed oxygen concentration falls outside the range ((calculated O2 concentration – negative offset, calculated O2 concentration + positive offset). Ranges and allowable O2 concentration deviations are given in the table below.

OR

In an extended overrun/decel fuel shutoff condition, an adaption factor is calculated for the response of the O2 sensor to ensure that the sensor reads 20.95% O2 in air. Code is set if adaption factor is outside the range 0.95 – 1.22.

(monitor operates when the vehicle is not undergoing particulate filter regeneration)

P229E Vs, COM, Ip1 short to battery – ASIC Diag2=1 and Vs, COM, Ip1  $\geq$  9V

Ip2 short to battery – Ip2  $\geq$  4.8V

Vs, COM, Ip1 short to ground – ASIC Diag2=1 and Vs, COM, Ip1 < 9V

Ip2 short to ground – Ip2  $\leq$  2V

Ip1 Open – Vs  $\leq$  225mV, Vs  $\geq$  625mV & -0.2mA  $\leq$  Ip1  $\leq$  0.2mA

Vs Open – Vs > 1.5V

COM Open – RpvS > RpvSA (target RpvS stored in sensor memory) or ASIC Diag1=1

Ip2 Open – Ip2-W  $\leq$  0.2V and Ip2-N  $\leq$  0.2V

Sensor Memory CRC check

Vs/Ip1 Cell Crack – Ip1 > 6.4mA

Ip2 Cell Crack – Ip2-W > 4.8V

P229F NOx Negative Offset – NOx Sensor greater than ~ - 10 ppm offset

NOx Positive Offset – NOx Sensor greater than ~20 ppm offset

Tip-in – Filtered tailpipe NOx on tip-in delta > 0 ppm

P220F Heater control failure – RpvS  $\geq$  0.2V and RpvS < TRpvS - 30 $\Omega$  or RpvS > TRpvS + 30 $\Omega$

Heater Open – Heater current < 0.4A

Heater short to battery –  $\Delta$  Heater Voltage > 0.2V

Heater short to ground –  $\Delta$  Heater Voltage > 0.2V

Heater performance failure – Heater current  $\geq$  0.4A and Heater Resistance  $\geq$  11 $\Omega$

P22A7 NOx/O2 Availability – > 1 PL (Healing mode) per cycle or > 9 sec of NOx/O2 not valid

P220B Battery failure – Battery > 17V or Battery < 10V

P0133 (O2 slow response) monitor operation

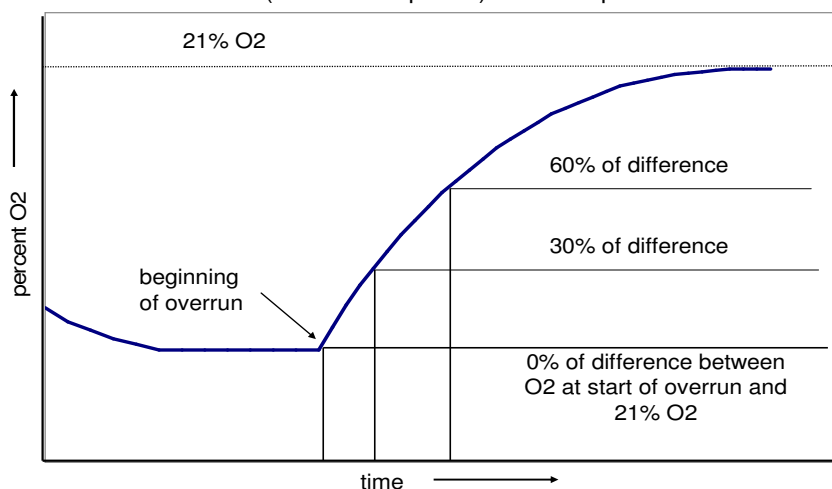

Oxygen Sensor Plausibility Measurement (P2A01) Evaluation Ranges and Allowable Deviations:				
	Range 1		Overrun	
	Minimum	Maximum	Minimum	Maximum
Engine speed (rpm)	1100	2700	100	4000
Fuel injection quantity (mg/stroke)	15	38	0	0.5
Air mass (mg/stroke)	400	1000	100	1000
Allowable deviation (% O2)	-7.0	5.5	-5.0	4.6

NOx Sensor Operation Modes

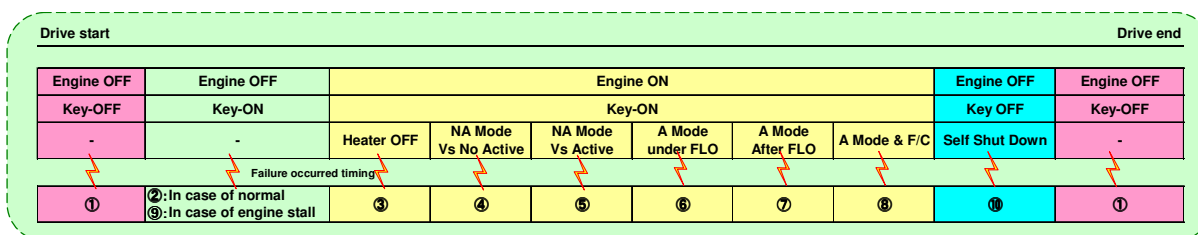

- Mode 1 – No voltage supply to module or sensor. Non-operational.
- Mode 2 – Voltage is supplied to module, yet voltage is not supplied to the sensor.
- Mode 3 – Voltage is supplied to module, yet voltage is not supplied to the sensor. Dew-point waiting period.
- Mode 4 – Voltage is supplied to the module and to the sensor. The Vs cell of the sensor is not active.
- Mode 5 – Voltage is supplied to the module and to the sensor. The Vs cell of the sensor is active.
- Mode 6 – Voltage is supplied to the module and to the sensor. Sensor is in fast light-off to quickly heat sensing element to operational temperature.
- Mode 7 – Voltage is supplied to the module and to the sensor. The sensor has exited fast light-off and O2 and NOx will be available during this mode.
- Mode 8 - Voltage is supplied to the module and to the sensor. The sensor has exited fast light-off and O2 and NOx will be available during this mode. During this mode a fuel cut condition is present, as communicated by the PCM.
- Mode 9 - Voltage is supplied to module, yet voltage is not supplied to the sensor.
- Mode 10 - No voltage supply to module or sensor. Non-operational.



# Particulate Matter Sensor

## Exhaust Gas Particulate Matter Sensor (PMS)

The particulate matter sensor (PMS) on the 6.7L diesel is used to detect high levels of particulate emissions resulting from a leak in the particulate filter. The sensor consists of an exhaust mounted probe and a sensor control module. On chassis certified vehicles the probe is mounted in the highest point of the kick-up pipe routed above the rear axle. On dyno certified vehicles the probe is mounted after the SCR near the NOx sensor and EGT14 sensor. The sensor module is mounted to the vehicle frame under the body near the probe. The sensor probe and the control module are permanently connected and cannot be serviced independently.

The PMS interfaces to the vehicle via a power supply, power ground, CAN low and CAN high. The sensor specific calibration factor, status of the sensor, temperature, electrode current, heater duty cycle, software ID, calibration ID, and various sensor diagnostic results are communicated of HSCAN to the PCM.

PMS Control Module Checks:	
DTCs	P24D0 Particulate Matter Sensor Supply Voltage Circuit Low U02A3 Lost Communication With PM Sensor U04A4 Invalid Data Received From PM Sensor
Monitor Execution	Continuous
Monitor Sequence	None
Sensors OK	Not applicable
Typical Monitoring Duration	P24D0 – 2 seconds U02A3 – 7 seconds U04A4 – 2 seconds

PMS Control Module Checks Entry Conditions:		
Entry condition	Minimum	Maximum
Battery voltage	11 V	16 V

PMS Control Module Checks Malfunction Thresholds:
P24D0: If battery voltage is > 15 V, voltage drop > 1.1 V if battery voltage is > 11.7 V, voltage drop > 2.1 V if battery voltage is < 11.7 V, voltage drop > 3 V
U02A3: PMS CAN message missing for more than 7 seconds
U04A4: PMS calibration factor transmitted is < 0.75 or > 1.25

The PMS probe consists of three internal parts: a heater, a temperature sensor and a set of particulate matter measurement electrodes. The sensor operates by accumulating exhaust particles in the gap separating the electrodes. As particles accumulate the resistance between the electrodes drops, and an electric current can flow due to the voltage potential applied. The duration of accumulation to a certain current threshold determines the leakage of the particulate filter. Because particles accumulate on the sensor, it must be regenerated occasionally by activating the sensor heater. The temperature of the part is controlled with feedback from the temperature sensor, and measurement of sensor temperature is used to correct sensor output for variation in resistivity of particulate matter as a function of temperature.

The PMS module handles basic circuit checks for the sensor components. Standard open and short circuit diagnostics are run on the temperature sensor and the heater by the PMS module and reported to the PCM via CAN messages.

<b>PMS Temperature Sensor Circuit Checks:</b>	
DTCs	P24C6 Particulate Matter Sensor Temperature Circuit
Monitor Execution	Continuous
Monitor Sequence	None
Sensors OK	Not applicable
Typical Monitoring Duration	P24C6 – 2 seconds

<b>PMS Temperature Sensor Circuit Checks Entry Conditions:</b>		
Entry condition	Minimum	Maximum
Battery voltage	11 V	16 V
Exhaust temperature	-39 degC	800 degC

<b>PMS Temperature Sensor Circuit Checks Malfunction Thresholds:</b>
Temperature sensor circuit voltage is < 0.3 volts or > 3 volts



<b>PMS Heater Circuit Checks:</b>	
DTCs	P24B3 Particulate Matter Sensor Heater Control Circuit/Open P24B4 Particulate Matter Sensor Heater Control Circuit Range/Performance
Monitor Execution	P24B3: Continuous during PMS regeneration P24B4: Continuous during PMS measuring
Monitor Sequence	None
Sensors OK	PMS Temperature
Typical Monitoring Duration	2 seconds

<b>PMS Heater Circuit Checks Entry Conditions:</b>		
Entry condition	Minimum	Maximum
Battery voltage	11 V	16 V
For P24B3, PMS heating on		
For P24B4, PMS heating off		

<b>PMS Heater Circuit Checks Malfunction Thresholds:</b>
P24B3: PMS heater current < 0.2 amps
P24B4: PMS heater voltage > 7 volts

In addition to basic circuit checks the temperature sensor in the PMS is monitored for offset and plausibility compared to other exhaust gas temperature sensors. The temperature offset check occurs at key-on after a long engine-off soak to ensure all sensors have stabilized to ambient temperature. The PMS temperature is compared to the average reading of three other exhaust temperature sensors. During PMS measurement, the sensor temperature is compared to a model of the sensor temperature to check plausibility. The model estimates PMS temperature based on exhaust gas temperature and exhaust pipe wall temperature. This monitor only runs while the PMS is not actively heating and sufficient time has elapsed since the last heating event to ensure that the sensor temperature has stabilized to the exhaust conditions.

<b>PMS Temperature Plausibility Checks:</b>	
DTCs	P24C7 Particulate Matter Sensor Temperature Circuit Range/performance
Monitor Execution	- Offset test once per cold start - Dynamic check during sensor measurement
Monitor Sequence	None
Sensors OK	EGT14
Typical Monitoring Duration	- Cold start test, 10 sec - Dynamic test, 120 sec

<b>PMS Temperature Plausibility Checks Entry Conditions:</b>		
Entry condition	Minimum	Maximum
Engine off time	6 hours	
Battery voltage	11 V	16 V
EGT for offset check	-40 degC	80 degC
Exhaust gas velocity	12 m/s	655 m/s
Vehicle speed	25 km/hr	250 km/hr
BARO	74.5 kPa	
Modeled PMS temperature for dynamic check	-40 degC	400 degC
Modeled PMS temperature change during dynamic check		30 degC

<b>PMS Temperature Plausibility Checks Malfunction Thresholds:</b>
- Difference between PM Sensor reported temperature and modeled temperature < -150 degC or > 60 degC
- Difference between PMS temperature and average of reference exhaust sensors > 45 degC
- PM sensor temperature at key-on < -40 degC

The resistance of the PMS heater is monitored as a surrogate for the performance of the heater. When the PMS is powered up, two short pulses are sent to the heater during which the current through the heater is measured. Using the measured supply voltage, the resistance of the heater can be calculated. The resistance is compared to a threshold based on the sensor temperature and reported over CAN.

<b>PMS Heater Checks:</b>	
DTCs	P24B7 Particulate Matter Sensor Heater Resistance
Monitor Execution	Once per drive at key on
Monitor Sequence	None
Sensors OK	PMS Temperature
Typical Monitoring Duration	10 seconds

<b>PMS Heater Checks Entry Conditions:</b>		
Entry condition	Minimum	Maximum
Battery voltage	11 V	16 V
PMS Temperature	-30 degC	150 degC
Change in PMS Temperature during monitor		150 degC

<b>PMS Heater Checks Malfunction Thresholds:</b>
PMS heater resistance @ -30 degC < 1.06 Ohms or > 2.93 Ohms
PMS heater resistance @ 150 degC < 1.81 Ohms or > 4.12 Ohms

Because the sensor electrode is normally open circuit and can exhibit a short circuit in case it is heavily loaded with PM, it poses unique challenges for on-board diagnostics. Monitoring the electrode for open circuit involves taking advantage of movement of sodium ions through the hot ceramic substrate of the sensor electrode. At sensor regeneration temperature, movement of the ions causes a current which is measured to ensure the integrity of the sensor electrodes. This form of open circuit check takes place at the end of sensor regeneration while the electrode is still hot. The check for short circuit takes place after the sensor has cooled below 425 °C immediately following regeneration when the sensor is sure to be free of any PM. During sensor operation, the positive electrode of the sensor is monitored to ensure the electrode supply voltage is in range. If the voltage drops due to a hardware failure in the sensor, a fault will be set. If a short circuit occurs in the electrode and sensor regeneration will be performed to ensure the short is not due to accumulation of soot, then a fault set.

<b>PMS Electrode Checks:</b>	
DTCs	P24AE Particulate Matter Sensor Circuit P24AF Particulate Matter Sensor Circuit Range/Performance P24B0 Particulate Matter Sensor Circuit Low P24B1 Particulate Matter Sensor Circuit High
Monitor Execution	P24AE – After each PMS regeneration P24AF – After each PMS regeneration P24B0 – Continuous during sensor measurement P24B1 – Continuous during sensor measurement
Monitor Sequence	None
Sensors OK	EGT
Typical Monitoring Duration	P24AE – 120 seconds P24AF – 120 seconds P24B0 – 1.6 seconds P24B1 – 3 seconds

<b>PMS Electrode Checks Entry Conditions:</b>		
Entry condition	Minimum	Maximum
Battery voltage	11 V	16 V
Key on		

<b>PMS Electrode Checks Malfunction Thresholds:</b>
P24AE: PMS current > 5 microamps after sensor regeneration
P24AF: PMS current during sensor regeneration less than 0.094 microamps
P24B0: PMS Voltage < 41.55
P24B1: PMS Current > 41 microamps

## Particulate Matter Sensor Sampling Monitor

To operate correctly, the PMS must have unrestricted exposure to exhaust gas. A monitor for PM sensor sampling checks the sensor once per drive for plugging with excessive soot and proper installation in the exhaust. The monitor evaluates the change in voltage required to maintain a constant sensor heater temperature for changes in exhaust gas velocity. In the event that the voltage, calculated from heater duty cycle, changes less than a calibrated threshold for certain magnitude changes in exhaust gas flow, a fault for a PM sensor sampling error is set. The sampling tube monitor runs during cold start before exhaust dewpoint is reached while the PMS is operating at a low heating level for contamination protection.

PMS Sampling Error Check:	
DTCs	P24DA Particulate Matter Sensor Exhaust Sample Error Bank 1
Monitor Execution	Once per drive
Monitor Sequence	None
Sensors OK	EGT14
Typical Monitoring Duration	3 minutes

PMS Sampling Error Check Entry Conditions:		
Entry condition	Minimum	Maximum
PMS in protective heating mode		
Exhaust gas acceleration	0.5 m/sec/sec	5 m/sec/sec
Time after engine start	10 sec	
Exhaust gas temperature	-3000 degC	3000 degC
Battery voltage	11 V	16 V
Engine running		

PMS Sampling Error Check Malfunction Thresholds:
Cumulative PM sensor voltage during exhaust gas velocity changes < 0.5 volts

## Particulate Matter Sensor Regeneration Monitor

To burn off accumulated particulates, the PMS must occasionally regenerate. This is accomplished by heating the sensor element to 785 °C for a period of time. The success of sensor regeneration is monitored by evaluating if the sensor is able to maintain the regeneration temperature for the time required to ensure all accumulated material is removed. The monitoring only takes place if vehicle conditions are such that the sensor is capable of regeneration. For example, the PMS may not be able to regenerate if the battery voltage is below normal and the engine is at peak power. This is because at the reduced voltage, the PMS heater may not be capable of providing the power required to reach the setpoint temperature.

PMS Regeneration Check:	
DTCs	P24D1 Particulate Matter Sensor Regeneration Incomplete
Monitor Execution	After each PMS regeneration
Monitor Sequence	None
Sensors OK	EGT14
Typical Monitoring Duration	120 seconds

PMS Regeneration Check Entry Conditions:		
Entry condition	Minimum	Maximum
Battery voltage	11 V	16 V
PMS heater power not exceeded		

PMS Regeneration Check Malfunction Thresholds:
PMS temperature < 775 degC or > 795 degC for 5 seconds

## Particulate Matter Filter Monitor Using PM Sensor

The DPF is monitored to ensure no leaks have developed in the substrate. The monitor runs anytime the filter is not being regenerated and the exhaust is sufficiently warm to allow operation of the PMS. In addition, the NOx, exhaust gas temperature and gas velocity must be at normal operating levels.

The DPF efficiency monitor compares the response of the tailpipe mounted PMS to a model of the expected PMS response to a threshold leak DPF. If the sensor response exceeds the model response, the DPF is interpreted as leaking more than the threshold and an error flag is set. The PMS response is a time required to a threshold current, 12 microamps. The modeled sensor response provides the estimated time the PM sensor should reach the threshold current as a function of the vehicle operating condition. The leakage rate of the DPF is indicated with a metric derived from how close to the 12 microamp threshold the observed sensor current got at the point in time the sensor model indicates the current threshold should have been reached for a sensor measuring an emission threshold DPF.

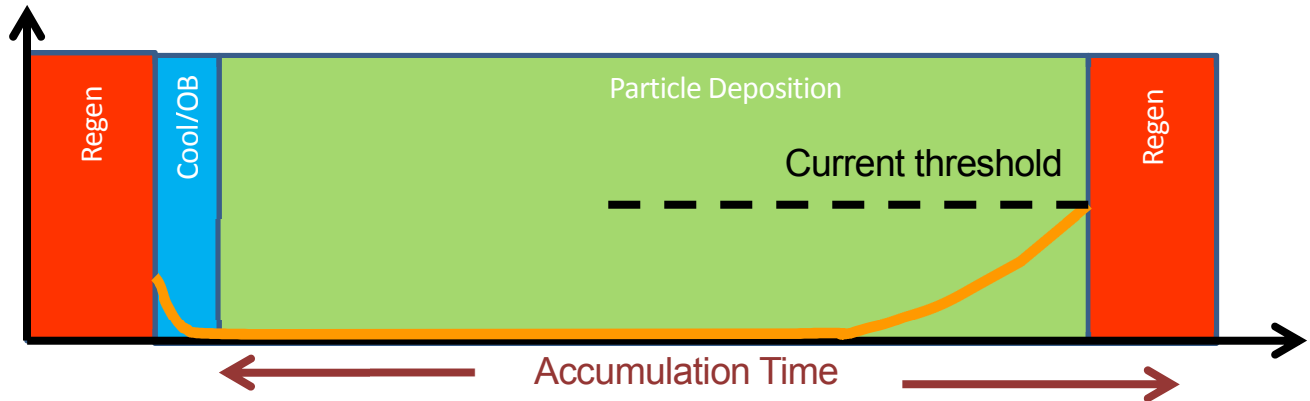

The results of the DPF monitor are reported as a ratio of the PMS sensor current observed at the time of monitor completion and the maximum sensor current possible for either an OK or failed DPF. The result is calculated as  $DPFLeakRate = 2 - \frac{PMSCurrent}{MaxOKDPFCurrent}$  for an OK DPF, yielding a leak rate between 1 and 2. For a failed DPF, the leak rate is calculated as  $DPFLeakRate = \frac{PMSCurrent - MaxPMSCurrent}{MaxOKDPFCurrent - MaxPMSCurrent}$  yielding a value between 0 and 1. The overall DPF leakage assessment is provided only after two or more results of the preceding calculations has completed and been averaged. An assessment of DPF leak is provided after the required number of sensor measurements has been taken. The measurements may span one or more drive cycles.

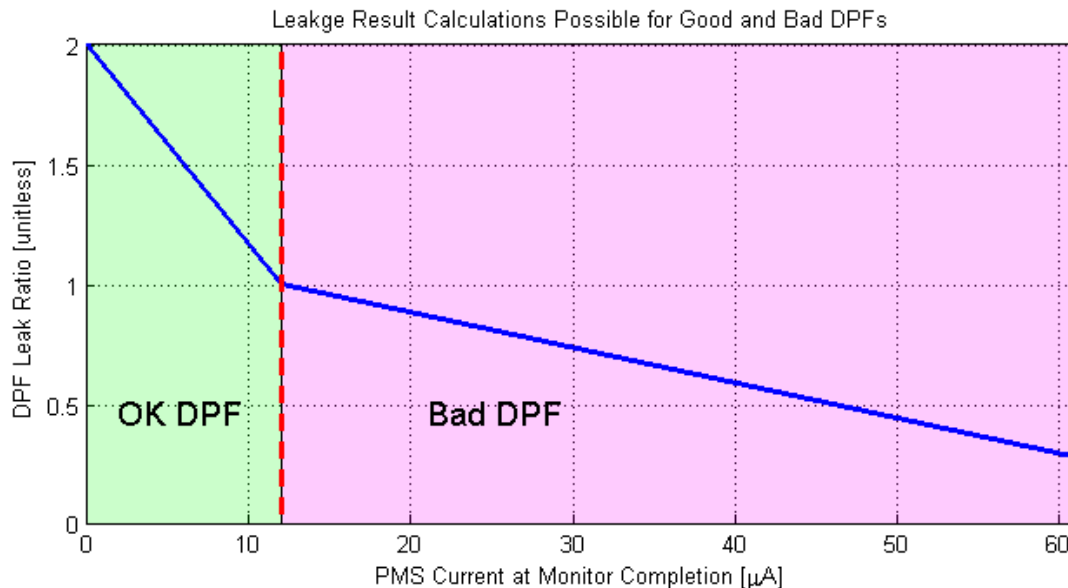

<b>DPF Efficiency Check:</b>	
DTCs	P2002 Particulate Filter Efficiency Below Threshold (Bank 1)
Monitor Execution	Continuous while PMS can measure
Monitor Sequence	None
Sensors OK	PMS, EGT, ECT, MAF, NOx, IAT
Typical Monitoring Duration	10 minutes

<b>DPF Efficiency Check Entry Conditions:</b>		
Entry condition	Minimum	Maximum
Dewpoint reached at PMS		
Not currently in DPF regeneration		
Time since DPF regeneration	600 sec	
PMS temperature		400 degC
Estimated soot load on DPF	0 g	300 g
Exhaust velocity	0 m/s	50 m/s
Exhaust pressure	74.5 kPa	135 kPa
EGT	65 degC	400 degC
Engine run time	10 sec	
Tailpipe NOx	200 ppm	

<b>DPF Efficiency Check Malfunction Thresholds:</b>
DPF leakage ratio of PMS response to modeled threshold DPF PMS response is below a threshold for a sufficient number of monitoring sessions
Ratio: 1 (unitless)
Debounce counter for number of failed sessions: 1
Counter for number of sessions to declare the monitor complete: 1



# EXHAUST GAS RECIRCULATION (EGR) SYSTEM MONITOR

## EGR Rate System Monitor

The EGR system is a closed loop control system that controls percent of EGR in the cylinder using the EGR valve and Throttle. The percent of EGR is calculated using two different methods and the difference between these two calculations is used to determine if the system is operating corrected. First, the expected amount of EGR in the cylinder is calculated using a model that is based on the commanded EGR and Throttle position. Second, the EGR in the cylinder is measured by subtracting the mass air sensor (MAF) reading from a speed-density model of the air charge into the cylinder. The speed-density model accounts for both fresh air and EGR and is based on the volumetric efficiency of the engine. High or excessive EGR flow is detected when the measured amount of EGR is greater than the expected amount of EGR. Low or insufficient EGR flow is detected when the measured amount of EGR is less than the expected amount of EGR. A slow EGR system is detected using the excessive EGR flow system monitor.

The monitor compares the two calculations, when a set of entry conditions are met, and determines if the system is operating correctly. The entry conditions are selected to ensure robust fault/non-fault detection. A summary of the entry conditions is shown in the tables below. The fault must be detected for a minimum amount of time before being reported. A timer counts up when the entry conditions are met and the fault is present. The timer counts down when the entry conditions are met, the fault is not present, and the current count is greater than 0. When this timer exceeds the time required detect a malfunction, the malfunction is reported.

EGR Flow Check Operation:	
DTCs	P0401 – Insufficient EGR Flow P0402 – Excessive EGR Flow
Monitor Execution	Continuous
Monitor Sequence	None
Monitoring Duration High Flow	4 seconds required to detect a malfunction
Monitoring Duration Low Flow	8 seconds required to detect a malfunction

Typical EGR Flow Check Entry Conditions (High Flow Detection):		
Entry Condition	Minimum	Maximum
Engine Torque	Monitor is released in a speed/load region as shown in the following figure.	
Engine RPM		
Engine Coolant Temperature	70 deg C	100 deg C
EGR Valve Position	0%	6%
Desired EGR Ratio	0%	15%
Ambient Pressure	74.5 kPa	
EGR System in Closed Loop Control		

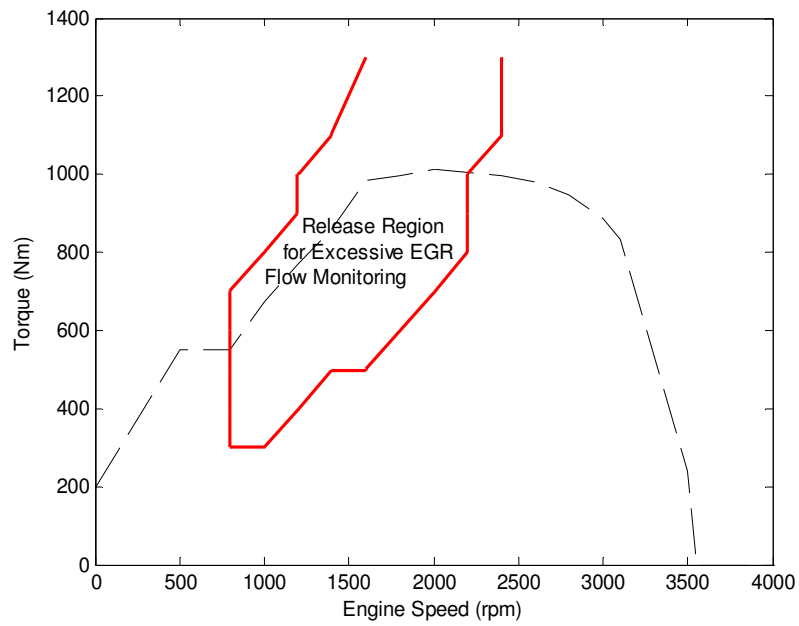

**Typical EGR High Flow Rate Malfunction Thresholds:**

Expected EGR Ratio – Measured EGR Ratio < -15 (function of engine speed / torque)

**Typical EGR Flow Check Entry Conditions (Low Flow Detection):**

Entry Condition	Minimum	Maximum
Engine Torque	Monitor is released in a speed/load region as shown in the following figure.	
Engine RPM		
Engine Coolant Temperature	70 deg C	100 deg C
EGR Valve Position	40%	60%
Desired EGR Ratio	0%	100%
Ambient Pressure	74.5 kPa	
EGR System in Closed Loop Control		

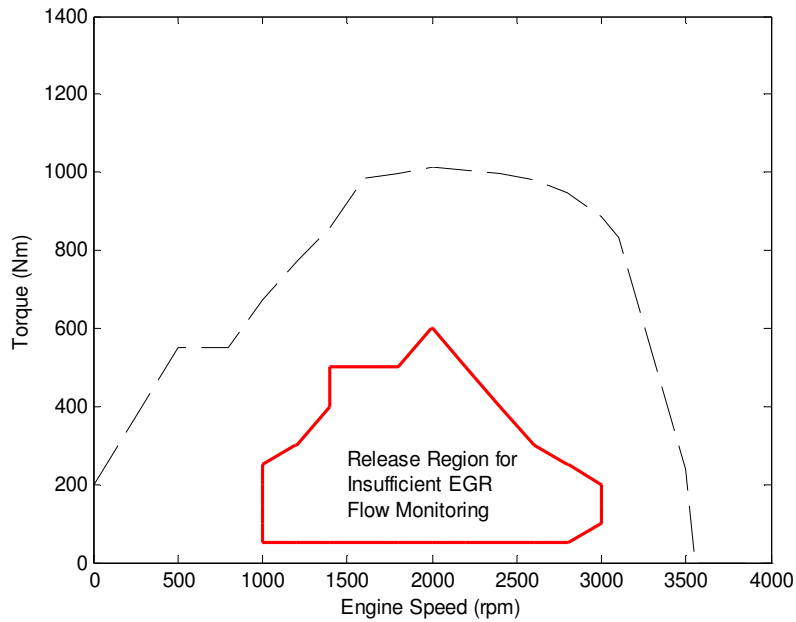

**Typical EGR Low Flow Rate Malfunction Thresholds:**

Expected EGR Ratio – Measured EGR Ratio > 10 (function of engine speed / torque)

## EGR Cooler / EGR Cooler Bypass Monitor

The functionality of the EGR cooler system, including the bypass valve and temperature sensor, is monitored by means of comparing measured EGR gas temperature downstream of the EGR cooler assembly with measured coolant temperature in the main coolant loop when certain engine operating conditions exist. The operating conditions in which this detection can occur are the monitor entry conditions. Following changes in engine operating conditions, there is a delay before the changes are reflected in the EGR system temperatures. Because of this delay the entry conditions include a number of timers which must complete before the monitor is released. When a condition feeding a timer is no longer met, the timer resets. EGR undercooling is detected using this EGR cooler monitor.

### Monitor Entry Condition Timer Locations

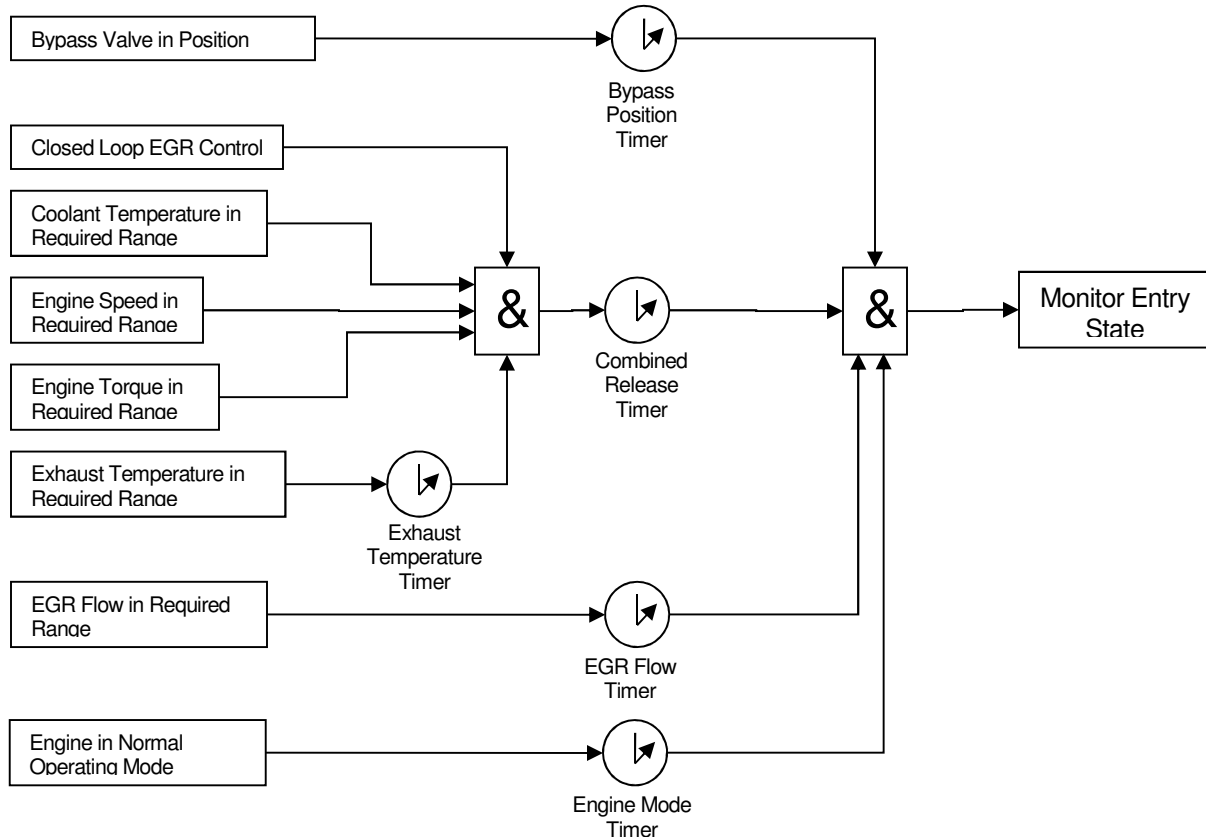

The undercooling monitor can detect when EGR is not being cooled sufficiently, for example, when the EGR cooler bypass is stuck in the bypass position. The entry conditions for EGR undercooling monitoring must be met for monitoring to take place. Once the entry conditions are met and while they continue to be met, the measured EGR temperature downstream of the EGR cooler assembly is compared to a threshold which is determined based on measured coolant temperature. A typical value for this threshold is 70 deg C above engine coolant temperature. If the measured EGR temperature downstream of the EGR cooler assembly is greater than the threshold, for a predetermined amount of time, a fault is detected.

**EGR Cooler (Undercooling) Monitor:**

DTCs	P2457 – EGR Cooler Performance
Monitor execution	Once per driving cycle , once entry conditions are met
Monitor Sequence	None
Monitoring Duration	12 seconds to detected a malfunction

**EGR Cooler/ECB Entry Conditions (Undercooling):**

Entry Condition	Minimum	Maximum
EGR Cooler Bypass Valve Command	Cooling Position	
EGR System in Closed-Loop Control		
Engine Coolant Temperature	70 deg C	130 deg C
Engine Speed	1100 rpm	3500 rpm
Engine Torque	200 Nm	1400 Nm
Exhaust Temperature	0 deg C	800 deg C
EGR Flow	0 g/s	42 g/s
Engine Operating Mode	Normal	

**EGR Cooler/ECB Entry Timers (Undercooling):**

Timer	Minimum Time
Bypass Position Timer	5 sec
Combined Release Timer	1 sec
Exhaust Temperature Timer	5 sec
EGR Flow Timer	5 sec
Engine Mode Timer	100 sec

**Typical Undercooling Malfunction Thresholds:**

Measured EGR temperature downstream of the EGR cooler assembly > Coolant Temperature + 70

For overcooling, EGR cooling system is monitored by intrusively moving the bypass door from the cooling position to the bypass position and looking at the response of the temperature out of the EGR cooler. The gradient (slope) of the temperature is compared to a threshold, if the gradient is less than the threshold for the entire monitoring duration, a fault is detected. In contrast, on a non-fault system, once the gradient exceeds the threshold, the monitor pass is latched. Once the monitor pass is latched, the bypass door returns to the cooling position to protect the engine hardware from overheating. The bypass door returns to the cooling position before the monitor is complete but the monitor continues to be released as long as the entry conditions are met. The monitor only completes once the monitor is released for the full monitoring duration, consecutively.

Monitoring is done during somewhat steady state operation at medium to high speed-load conditions with sufficient EGR flow. Entry are selected so the monitor is released to run when the conditions are correct. The entry conditions required to release the monitor are listed EGR Cooler (Intrusive) Entry Conditions table below. The bypass door must be in the cooling position for a minimum calibrated time for the monitor to be released. The rest of the entry conditions must be met for a different minimum calibrated time before the monitor is released.

To protect the hardware, the monitor is not allowed to re-release immediately if the release is lost because one of more of the entry condition are no longer met.

<b>EGR Cooler (Intrusive) Monitor:</b>	
DTCs	P245A – Exhaust Gas Recirculation (EGT) Cooler Bypass Control Circuit (bank 1) P24A5 – Exhaust Gas Recirculation Cooler Bypass Control Stuck (Bank 1)
Monitor execution	Once per driving cycle, once entry conditions are met
Monitor Sequence	None
Monitoring Duration	P245A: 3 sec to detect a malfunction, P24A5: 12 sec to detect a malfunction

<b>EGR Cooler (Intrusive) Entry Conditions:</b>		
Entry Condition	Minimum	Maximum
EGR Cooler Bypass Valve Command (only evaluated during monitor pre-release)	Cooling Position	
EGR System in Closed-Loop Control		
Engine Coolant Temperature	70 deg C	140 deg C
Engine Speed	575 rpm	900 rpm
Filtered Absolute Value of the Gradient of Engine Speed		150 rpm/s
Engine Torque	70 Nm	300 Nm
Filtered Absolute Value of the Gradient of Engine Torque		150 Nm/s
Exhaust Temperature	300 deg C	700 deg C
Filtered Absolute Value of the Gradient of Exhaust Temperature		8 deg C / s
Fuel Injection Quantity	0.1 g/rev	0.4 g/rev
Filtered Absolute Value of the Gradient of Fuel Injection Quantity		0.05 g/rev/s
EGR Flow	22 g/s	112 g/s
Filtered Absolute Value of the Gradient of EGR Flow		22 g/s/s
Modeled Intake Manifold Temperature		140 deg C
Engine Operating Mode	Normal	

**Typical Malfunction Thresholds:**

P245A: Measured Gradient of EGR Downstream Temperature &lt; 3 deg C / s

P24A5: Measured EGR temperature downstream of the EGR cooler assembly &lt; Coolant temperature +16C

**EGR System Slow Response**

Slow responding EGR systems are detected through the EGR rate system monitor.

**EGR Control Limits Monitor**

The control limit monitor functions continuously during normal (non-regen) closed-loop operation. The control limits monitor compares the desired percent of EGR with the measured percent of EGR. If the error between these is greater than the threshold for the required duration of time, a fault is set. Specifically, a timer counts up when the entry conditions are met and the fault is present. The timer counts down when the entry conditions are met, the fault is not present, and the current count is greater than 0. When this timer exceeds the time required detect a malfunction, the malfunction is reported.

**EGR Closed-loop Control Limits Check Operation:**

DTCs	P04DA (Closed Loop EGR Control At Limit - Flow Too High) P04D9 (Closed Loop EGR Control At Limit - Flow Too Low)
Monitor Execution	Continuous
Monitor Sequence	None
Monitoring Duration	20 seconds to detect a malfunction

**Typical EGR Closed-loop Control Limits Check Entry Conditions:**

No Air System Faults

EGR system in closed loop EGR control

**Typical EGR Control Limits Malfunction Thresholds:**

Desired EGR Ratio – Measured EGR Ratio &lt; -60 (function of Engine Speed / Torque)

or

Desired EGR Ratio – Measured EGR Ratio &gt; 45 (function of Engine Speed / Torque)

## Mass Airflow Closed-loop Control Limits Monitor

During DPF regeneration the engine control system controls the mass of fresh air into the cylinder using the EGR valve and throttle valve. In this operating mode, the desired mass of fresh air in the cylinder is compared to the actual mass of air entering the cylinder. If the error is greater than the threshold for the required duration, a fault is set. The monitor is released when the system is in closed loop control. Specifically, a timer counts up when the entry conditions are met and the fault is present. The timer counts down when the entry conditions are met, the fault is not present, and the current count is greater than 0. When this timer exceeds the time required detect a malfunction, the malfunction is reported.

<b>Mass Airflow Closed-loop Control Limits Check Operation:</b>	
DTCs	P02EC - Diesel Intake Air Flow Control System - High Air Flow Detected P02ED - Diesel Intake Air Flow Control System - Low Air Flow Detected
Monitor Execution	Continuous
Monitor Sequence	None
Monitoring Duration	20 seconds required to detect a malfunction

<b>Typical Mass Air Flow Closed-loop Control Limits Check Entry Conditions:</b>
No Air System Faults
EGR System in closed loop air mass control

<b>Typical Air Mass Control Limits Malfunction Thresholds:</b>
Desired Air Mass – Measure Air Mass > 400 (function of Engine Speed / Torque)
or
Desired Air Mass – Measure Air Mass < -400 (function of Engine Speed / Torque)



# BOOST PRESSURE CONTROL SYSTEM MONITORING

## Intrusive Turbo Position and Response Monitoring

The 6.7L engine is equipped with an oil pressure actuated, variable vane turbocharger. The variable geometry turbo (VGT) does not have a position sensor, so the position is inferred using a duty cycle to position transfer function. To verify actual position based on the nominal transfer function, an intrusive monitor sweep is performed. When entry conditions are met, the intrusive monitor for VGT closes the EGR valve, opens the throttle and then commands the output PWM to open and closed position for a calibratable duration. Typical values are 85%, then 25%. The minimum and maximum MAP values are saved and compared to a threshold. If the desired separation in MAP pressure isn't achieved, a fault is detected. If the desired separation in MAP is achieved, the test is considered a pass.

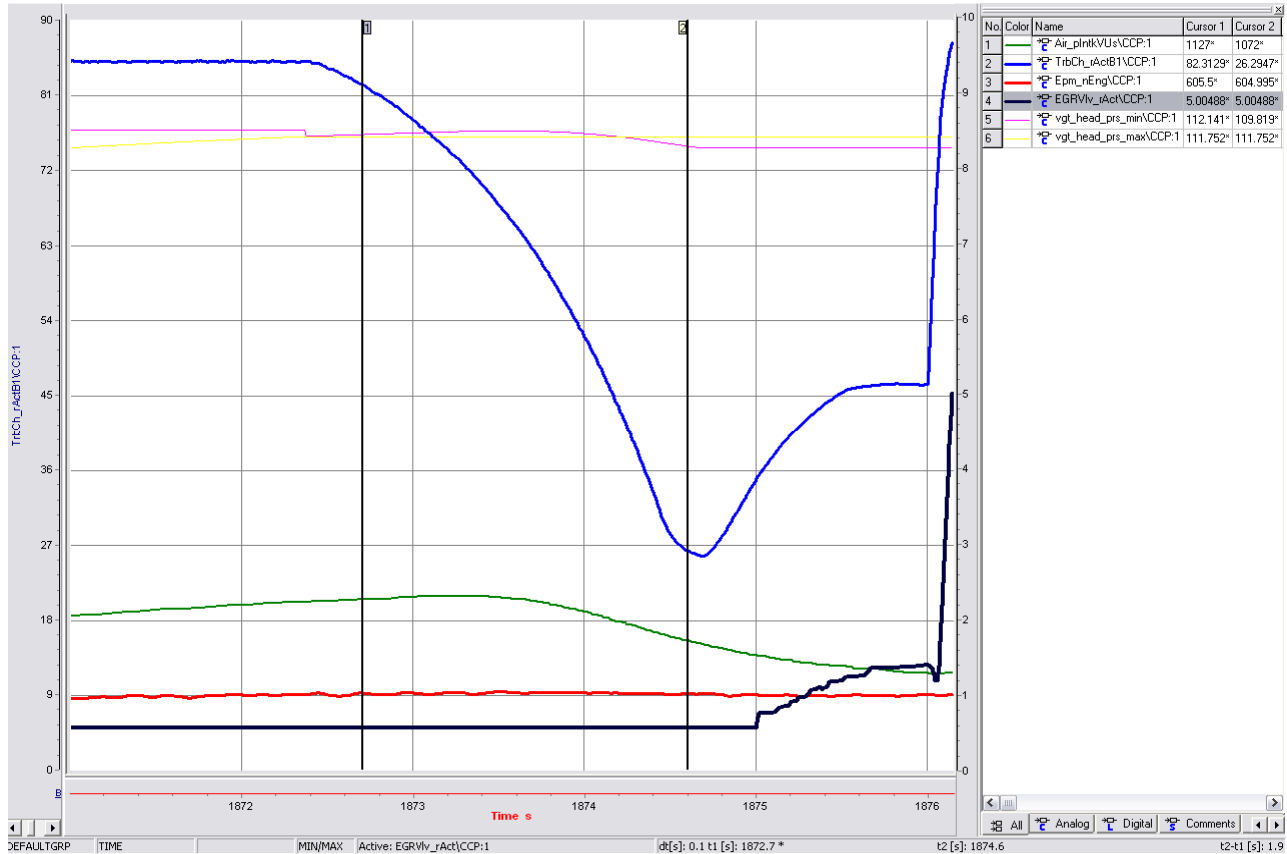

In the example above, at 1871 seconds, the EGR valve is commanded closed, after 3 seconds with EGR off and turbocharger at 85% position, the turbocharger is opened up to 25% position. The 25% position is held for 4 seconds. If desired separation of 2kpa at sea level is achieved the test is considered a pass. If desired separation isn't achieved the test is completed and failed.

Note: this monitor also serves to monitor for a slowly responding boost pressure system due to the time component of the threshold.

<b>VGT Monitor:</b>	
DTCs	P132B - Turbocharger/Supercharger Boost Control "A" Performance
Monitor Execution	Once per driving cycle
Sensors OK	ECT, MAP, VS
Typical Monitoring Duration	7 seconds for full VGT monitoring cycle if pressure abort threshold hasn't been reached

<b>Typical VGT Monitor Entry Conditions:</b>		
Entry Condition	Minimum	Maximum
Engine speed for learning	500 rpm	760 rpm
Pedal position allowed for learning		0.5 %
Engine coolant temperature for learning	70 deg C	124 deg C
Fuel quantity allowed for learning		20 mg/stoke
Vehicle speed for learning		3 mph
Loop counts after brake cycle		800 counts
Barometric Pressure	67 kPa	102 kPa
Time after engine start	120 seconds	

<b>Typical VGT Monitor Malfunction Thresholds:</b>
Response from 25% VGT position to 85% VGT position in 4 seconds results in a change in manifold pressure of 2 kPa or greater at sea level or 1.25 kPa at 8000 feet.

## Overboost Monitoring

The 6.7L engine utilizes a closed loop boost pressure controller to maintain desired boost pressure set point under all temperature ranges and engine operating modes. The overboost monitor compares the desired vs. actual measured boost pressure while in a specific range of closed loop boost pressure operation. If the boost pressure governor deviation is greater than the calibrated threshold for 7 seconds, a fault is detected and the P-code is set. The closed loop monitoring window is defined as any inner torque above 50 nm, and any engine speed above 1000 rpm. Torque window and threshold slightly different for dyno cert due to different turbocharger configuration, calibration, and air path response.

This diagnostic will detect a turbo slowly responding or stuck in the primarily closed condition.

Overboost Monitor:	
DTCs	P0234 - Turbocharger/Supercharger "A" Overboost Condition
Monitor Execution	Continuous
Monitor Sequence	None
Sensors OK	ECT, MAP, MAF,
Typical Monitoring Duration	7 seconds for fault detection

Typical Overboost Monitor Entry Conditions:		
Entry condition	Minimum	Maximum
Engine Torque	50 Nm	
Engine Speed	1000	4000

Typical Overboost Monitor Malfunction Thresholds:
If desired boost pressure – actual boost pressure < -15.0 kPa for 7 seconds, a fault is detected.

## Threshold Overboost Monitoring

For the pickup applications, use of the engine brake function can result in conditions where a momentary slow response of the turbocharger vanes to movement can result in a transient high pressure condition that can be erroneously detected as overboost by the pressure based monitor. Instead, a monitor of exhaust pressure above a maximum threshold is used as the threshold overboost monitor.

Threshold Overboost Monitor:	
DTCs	P259F - Turbocharger "A" Boost Control Position At High Limit
Monitor Execution	Continuous
Monitor Sequence	None
Sensors OK	ECT, MAP, MAF
Typical Monitoring Duration	2 sec

Typical Threshold Overboost Entry Conditions:		
Entry condition	Minimum	Maximum
Key-on		
Battery voltage (IVPWR)	9 V	16.25 V

Typical Threshold Overboost Monitor Malfunction Thresholds:
If exhaust pressure > 5.5 bar absolute for 2 seconds, the fault sets.

## Underboost Monitoring

The underboost monitor works in a similar fashion to the overboost monitor by comparing the desired vs. actual measured boost pressure while in a specific range of closed loop boost pressure operation. If the boost pressure governor deviation is greater than the calibrated threshold for 7 seconds, a fault is detected and the P-code is set. The closed loop monitoring window is defined as any inner torque above 50 nm, and any engine speed above 1500 rpm. The threshold limit is wider for the underboost monitor due to transient boost system response, compensation for boost pressure lag, and short term (1-2 second) momentary torque truncation when air path torque is kept high, but fueling is limited for component protection.

This diagnostic will detect a gross air path leak such as the turbo discharge or CAC discharge tube being blown off, major pre-turbo exhaust leaks, or a turbo slowly responding or stuck in the open VGT position.

Underboost Monitor:	
DTCs	P1247 - Turbocharger Boost Pressure Low P0299 – Turbocharger/Supercharger “A” Underboost Condition
Monitor Execution	Continuous
Monitor Sequence	None
Sensors OK	ECT, MAP, MAF,
Typical Monitoring Duration	7 sec

Typical Underboost Monitor Entry Conditions:		
Entry condition	Minimum	Maximum
P1247:		
Engine Torque	50 Nm	
Engine Speed	1000 rpm	4000 rpm
P0299:		
Entry condition	Minimum	Maximum
Engine Torque	200 Nm	700 Nm
Engine coolant temperature	-7 deg C	
Ambient air temperature	-7 deg C	
Barometric Pressure	75 kPa	110 kPa
MAP steady state pressure		100 kPa
TOxiCatUs Temperature	99 deg C	
Mass Air Flow		1300 kg/h
Not in Cold Start Warm-up Mode		
Regeneration Status	None	

Typical Underboost Monitor Malfunction Thresholds:
P1247: If desired boost pressure – actual boost pressure > 15 kPa for 7 seconds, a fault is detected.
P0299: If control effort percent is > threshold for 4 seconds and exhaust lambda is <1.33, a fault is detected.

Typical Threshold Underboost monitor (P0299) Threshold Map												
RPM/TRQ	600	750	1000	1200	1600	2000	2250	2500	2750	3000	3250	3500
0	50	50	50	50	50	50	50	50	50	50	50	50
100	50	50	50	50	50	50	50	50	50	50	50	50
150	50	50	50	50	50	50	50	50	50	50	50	50
200	50	50	20	12	12	12	12	12	12	25.5	25.5	25.5
250	50	50	20	12	12	12	12	12	12	27.5	27.5	25.5
300	50	50	20	12	12	12	12	12	12	27.5	27.5	25.5
350	50	50	20	12	12	12	12	12	12	27.5	27.5	25.5
400	50	50	20	12	12	12	12	15	15	25.5	25.5	25.5
450	50	50	20	12	12	12	12	15	16	25.5	25.5	25.5
500	50	50	20	12	12	12	12	18.5	18.5	25.5	25.5	25.5
600	50	50	20	12	12	12	12	18.5	22.5	25.5	25.5	25.5
700	50	50	20	12	12	12	12	18.5	22.5	25.5	25.5	25.5

### Charge Air Cooler Monitoring

The 6.7L engine is equipped with an air to water charge air intercooler. The CAC is on a secondary coolant loop, independent from the main engine coolant system. The temperature at the outlet of the cooler is measured as TCACDs, however the temperature going into the cooler is modeled.

To detect a CAC under cooling situation, the efficiency of the cooler is modeled at various speeds and airflows via a 3d speed/airflow multiplier table, providing a modeled cooler out temperature. Cooler efficiency \* compressor out temperature = modeled cooler out temp. This modeled cooler out temp is then compared to the measured coolant out temp, if the difference is less than a threshold curve or greater than a threshold, a fault is detected and a p-code is set.

Charge Air Cooler Monitor:	
DTCs	P026A - Charge Air Cooler Efficiency Below Threshold P007E - Charge Air Cooler Temperature Sensor Intermittent/Erratic (Bank 1)
Monitor Execution	Continuous
Monitor Sequence	None
Sensors OK	ECT, MAP, MAF
Typical Monitoring Duration	4 seconds for fault detection

**Typical Charge Air Cooler Monitor Entry Conditions:**

Entry condition	Minimum	Maximum
Engine speed	1100 rpm	3350 rpm
Engine coolant temperature	70 deg C	
Ambient air temperature	-7 deg C	
Barometric Pressure	74.5 kPa	110 kPa
Manifold absolute pressure	120 kPa	
Intake air temperature	-7 deg C	
Injection quantity	20mg/stk	85mg/stk

**Typical Charge Air Cooler Monitor Malfunction Thresholds:**

P026A - If the difference of measured temperature and modeled temperature is less than -15 deg C at 0 deg C compressor out temp, or less than -10 deg C at 250 deg C compressor out temp, a fault is set.

P007E – If the difference of measured temperature and modeled temperature is greater than 35 deg C a fault is set.

## PARTICULATE MATTER (PM) FILTER MONITORING

### DPF Filter Efficiency Monitor (3.2L only)

The DPF is monitored to ensure no leaks have developed in the substrate. The monitor runs after a regeneration event where sufficient time was spent above a temperature threshold (in order to insure a proper regen).

The DPF Filter Efficiency monitor compares the calculated restriction (from a sensor measuring delta pressure across the DPF) to the expected restriction calculated from a soot model (using various engine sensors as inputs). After a successful regeneration event, the monitor waits for DPF temperatures to fall below a threshold (400 degC, to allow for an accurate soot estimate) and for a small quantity of soot to build up in the DPF (approx 3 grams). At this point, the monitor performs a filtering routine on the calculated restriction (from deltaP sensor) and locks in the initial restriction. Once sufficient soot has built up in the DPF (based on integrated soot from the soot model), the monitor will repeat the filtering routine on the calculated restriction (from deltaP sensor) and from the estimated soot in the DPF (from soot model). The ratio of restrictions (actual vs soot estimate) is compared to a threshold. If the ratio is less than a threshold, an error flag is set. The monitor allows for multiple monitoring sessions in order to provide debouncing before declaring the monitor as a pass or fail. When a sufficient number of sessions have been completed, the monitor is declared complete. The number of sessions with a failed result is compared to a threshold. If the number of failed sessions is greater than a threshold, the monitor is declared as failed and the code is set.

DPF Monitor:	
DTCs	P2002 – Diesel Particulate Filter Efficiency Below Threshold
Monitor Execution	P2002: Once per trip after a DPF regeneration
Monitor Sequence	None
Sensors OK	EGT, DPFP, CKP, ECT (P0117, P0118), EGT13 EGT14, MAF, IAT, DPFDp
Typical Monitoring Duration	Once between regeneration events

Typical DPF Monitor Entry Conditions:		
Entry condition	Minimum	Maximum
DPF temperature during regen (average of DPF inlet/outlet)	550 degC	
Time above temp threshold in regen	300 sec	
DPF temperature (post-regen, to trigger monitor)		400 degC
Estimated soot load in DPF		38.5 grams
Estimated soot consumed due to passive regen		10 grams
DPF temperature (inlet or outlet)		500 degC
No codes for sensors used as inputs to the monitor		
Not currently in a regeneration event		
Exhaust volumetric flow	300 m3/hour	1800 m3/hour
Ambient air temperature	-6.7 decC	
Ambient pressure	74.5 kPa	
DPF restriction not being calculated from open loop soot estimation		
Percentage of integrated soot under conditions where soot model is not accurate		32%



**Typical DFP Monitor Malfunction Thresholds:****DPF Efficiency Test: (P2002)**

Ratio of restriction from delta pressure sensor vs soot model is below a threshold for a sufficient number of monitoring sessions. Typical values for thresholds:

Ratio of restrictions: 0.70 (unitless)

Debounce counter for number of failed sessions: 3

Counter for number of sessions to declare the monitor complete: 3

**DPF Filter Missing Substrate Monitor**

The DPF is monitored to ensure that the filter has not been removed. The DPF Missing Substrate monitor compares the measured pressure upstream of the DPF to a threshold (function of volumetric exhaust flow). A debounce counter will increment when the pressure is below the threshold and decrement if the pressure is above the threshold (clipped to a minimum of 0). When the debounce counter exceeds a threshold, a fault is indicated.

**Monitor Summary:**

DTCs	P244A – Diesel Particulate Filter Differential Pressure Too Low
Monitor execution	P244A: Continuous while meeting entry conditions
Monitor Sequence	None
Sensors OK	EGT, DPFP, CKP, ECT (P0117, P0118), EGT13 EGT14, MAF, IAT
Monitoring Duration	90 sec

**Typical Entry Conditions:**

Entry condition	Minimum	Maximum
Exhaust volumetric flow	300 m3/hour	2400 m3/hour
Not a regeneration event		
Intake air temperature	-20 deg C	
Engine coolant temperature	50 deg C	

**Typical Malfunction Thresholds:****DPF Differential Pressure Test: (P244A)**

Measured DPF inlet pressure is below a threshold (function of engine exhaust volumetric flow) for 90 seconds. Typical values for threshold:

Flow (m <sup>3</sup> /hr)	300	600	900	1200	1500	1800	2100	2500
Pressure (kPa)	7.99	15.02	27.94	47.13	72.80	104.94	143.45	204.61

## DPF Frequent Regeneration Monitor

The DPF Frequent Regeneration monitor calculates the distance between aftertreatment regeneration events. The distance between successive regeneration events is calculated and the average distance is calculated for the two most recent regeneration events. If the distance between regen events is below a threshold, a fault is indicated.

Monitor Summary:	
DTC	P2459 – Diesel Particulate Filter Regeneration Frequency
Monitor execution	During each completed regeneration event
Monitor Sequence	None
Sensors OK	DPFP

Typical Entry Conditions:		
Entry condition	Minimum	Maximum
Regeneration runs to completion (not aborted by customer input or drive cycle)		
Not in “degraded regen” mode due to DPF pressure sensor error		
Fraction of time spent in speed/load conditions where monitor is reliable	0.20	

Typical Malfunction Thresholds:
A fault is stored when the average distance between regeneration events is below a threshold. Typical threshold is 42 km.

## DPF Incomplete Regeneration Monitor

The DPF Incomplete Regeneration monitor is used to detect an event where the DPF is not fully regenerated. If a regeneration event is aborted due to duration and the restriction of the DPF is still above a threshold, a fault is indicated. Upon the first occurrence of an incomplete regen, the system is put into a “degraded” regen mode. Another regen will be forced in approximately 150 miles unless a normal regen is triggered by the soot load first.

Monitor Summary:	
DTC	P24A2 – Diesel Particulate Filter Regeneration Incomplete
Monitor execution	During each DPF regeneration cycle
Monitor Sequence	None
Sensors OK	EGT11, EGT12, EGT13, EGT14, DPFP, INJ
Monitoring Duration	20 minutes (maximum)

Typical Entry Conditions:		
Entry condition	Minimum	Maximum
Monitor is activated during Aftertreatment regeneration events		
Ambient air temperature	-6.7 degC	
Ambient pressure	74.5 kPa	
Engine speed	1000 rpm	3500 rpm
Engine Indicated Torque	150 N-m	1500 N-m
Engine Coolant Temperature	70 degC	
Minimum time with valid entry conditions (function of regen duration)		

Typical Malfunction Thresholds:
If the restriction is above a threshold, a fault is indicated.

## DPF Feedback Control Monitors

The system is monitored to ensure that closed loop control of the regeneration event is initiated within a reasonable period of time. The monitor runs during a regeneration event and compares the time in closed loop control to the total time in regen. If the time in closed loop control is less than a threshold (a function of total time in regen), then a fault is indicated.

If the closed loop controller is saturated at its limits and the temperature is not within the desired limit, a timer will increment. If control is regained, the timer will decrement. At the end of the regeneration event, if this timer exceeds a threshold (a function of total time in regen), a fault is indicated

Note: Ford Motor Company 2011 diesel programs are using in-cylinder post injection to achieve regeneration, not external exhaust injection. The Post injection is monitored during this feedback monitor; there is no additional monitor for "active / intrusive injection"

Monitor Summary:	
DTC	P24A0 – DPF Temperature Control P249F – Excessive Time To Enter Closed Loop DPF Regeneration Control
Monitor execution	During an active regeneration event
Monitor Sequence	None
Sensors OK	TIA, ECT, AMP, EGT11, EGT12, EGT13, EGT14
Monitoring Duration	Once per regeneration event

Typical Entry Conditions:		
Entry condition	Minimum	Maximum
Engine Speed	1200 rpm	3500 rpm
Indicated Torque Setpoint	200 Nm	1500 Nm
Ambient Temperature	-6.7 deg C	
Coolant Temperature	70 deg C	
Barometric Pressure	74.5 kPa	

Typical Malfunction Thresholds:
P249F - If the time in closed loop operation is less than a threshold (function of total time in regen), a fault is indicated.
P24A0 - If the difference between desired and actual temperature is greater than a threshold for a sufficient period of time, a fault is indicated.

## DPF Restriction Monitor

The DPF is monitored for conditions where it may be overloaded. The monitor compares the calculated restriction of the DPF to a threshold. If the threshold is exceeded for a sufficient period of time, a wrench light and a MIL will be illuminated and engine output will be limited and EGR is disabled.

Monitor Summary:	
DTCs	P246C - Diesel Particulate Filter Restriction – Forced Limited Power
Monitor execution	Continuous while meeting entry conditions
Monitor Sequence	None
Sensors OK	DPFP
Monitoring Duration	300 seconds

Typical Entry Conditions:		
Entry condition	Minimum	Maximum
Engine Speed	625 rpm	

Typical Malfunction Thresholds:
Diesel Particulate Filter Restriction – Forced Limited Power (P246C) (Immediate MIL and Wrench Light) Calculated normalized restriction is 2.0 times the normal value for soot load.

# ENGINE COOLING SYSTEM MONITORING

## Thermostat Monitor

The Thermostat Monitor checks that the thermostat is operating properly by modeling Engine Coolant Temperature (ECT) based on engine fueling, engine speed, vehicle speed, and the ambient temperature. There are increment and decrement portions to the model; the increment is based on engine speed and fuel quantity, while the decrement is derived from calculated radiator efficiency based on coolant delta temp to ambient and vehicle speed. The model is delayed by 60 seconds after engine start to negate potential errors due to block heater use. It is also suspended while in catalyst warm-up mode due to errors in fuel quantity heat being contributed to the coolant.

Once that estimation reaches the thermostat start-to-open temperature, if the actual measured ECT has not reached a minimum warm-up temperature and the driver has not spent too much time in part fuel cut off (over 30%), too low load (over 70%), too high vehicle speed (over 70%), or too low vehicle speed (over 70%) - then the thermostat is determined to be stuck open.

Thermostat Monitor:			
DTCs	P0128 –Coolant Temp Below Thermostat Regulating Temperature		
Monitor Execution	Continuous		
Monitor Sequence	None		
Sensors OK	Engine Coolant Temperature (ECT), Intake Air Temperature (IAT), Vehicle Speed (VS)		
Typical Monitoring Duration	Nominal time it takes for engine to warm up to thermostat "Start-To-Open" temperature – see approximate times below. (Note: Unified Drive Cycle is 23.9 minutes long)		
	Ambient Temperature	Drive Cycle	Completion Time
	-7 deg C	Unified Drive Cycle x2	40 min
	21 deg C	Unified Drive Cycle	19 min
	38 deg C	Unified Drive Cycle	14 min

Typical Thermostat Monitor Entry Conditions:		
Entry condition	Minimum	Maximum
Modeled engine coolant temperature	90 deg C	
Engine coolant temperature at start	-7 deg C	54 deg C
Intake air temperature at start	-7 deg C	
Ratio of time that the vehicle speed is above, 85 km/hr, to the total monitoring time		70%
Ratio of time that the engine fueling is below 20 mg/str to the total monitoring time		30%
Ratio of time that the engine torque is below 60 n/m to the total monitoring time		70%
Ratio of time that the vehicle speed is below 45 km/hr to the total monitoring time		70%

Typical Thermostat Monitor Malfunction Thresholds:
Measured Engine Coolant Temperature < 70.2 deg C when modeled coolant temp > 90 deg C

## Primary Coolant Temp Rise Monitoring

To ensure the primary ECT sensor has not stuck below normal operating range, a simple rise check to verify a minimum rise in coolant temperature over a calibratable time has been implemented. If coolant temperature at start is greater than -35 deg C and less than 54 deg C, the monitor is enabled. At -35 deg C, the coolant is expected to rise up to -7 deg C in 291 seconds or less. If -7 deg C coolant temp. is not achieved in the required 291 second timeframe, a fault is detected. At a -7 deg C start temp, the coolant is expected to rise to 40 deg C in 5450 seconds- assuming worst case with EGR off, vehicle idling in neutral with heater on. Again, if the minimum temperature is not achieved in the required time, a fault is detected. This diagnostic is used in conjunction with the oil vs. coolant plausibility check, thermostat model, and SRC checks to verify proper ECT operation and engine warm-up.

<b>ECT Rise Monitor:</b>	
DTCs	P0116 - Engine Coolant Temperature Sensor 1 Circuit Range/Performance
Monitor Execution	Once per trip
Monitor Sequence	None
Sensors OK	ECT
Typical Monitoring Duration	291 seconds at -35 deg C start temp. idle only 5150 seconds at -7 deg C start temp, idle only

<b>Typical ECT Rise Monitor Entry Conditions:</b>		
Entry condition	Minimum	Maximum
Engine coolant temperature	-35 deg C	54 deg C
Engine speed	400 rpm	

<b>Typical ECT RiseMonitor Malfunction Thresholds:</b>
291 seconds at -35 deg C start temp to rise to -7 deg C
5150 seconds at -7 deg C start temp to rise to 40 deg C

## Secondary Coolant Temp Rise Monitoring

The 6.7L engine has a secondary coolant loop with two thermostats, a 20C thermostat for the charge air cooler and fuel cooler, and a 45C thermostat for the EGR cooler and trans cooler. System schematic below:

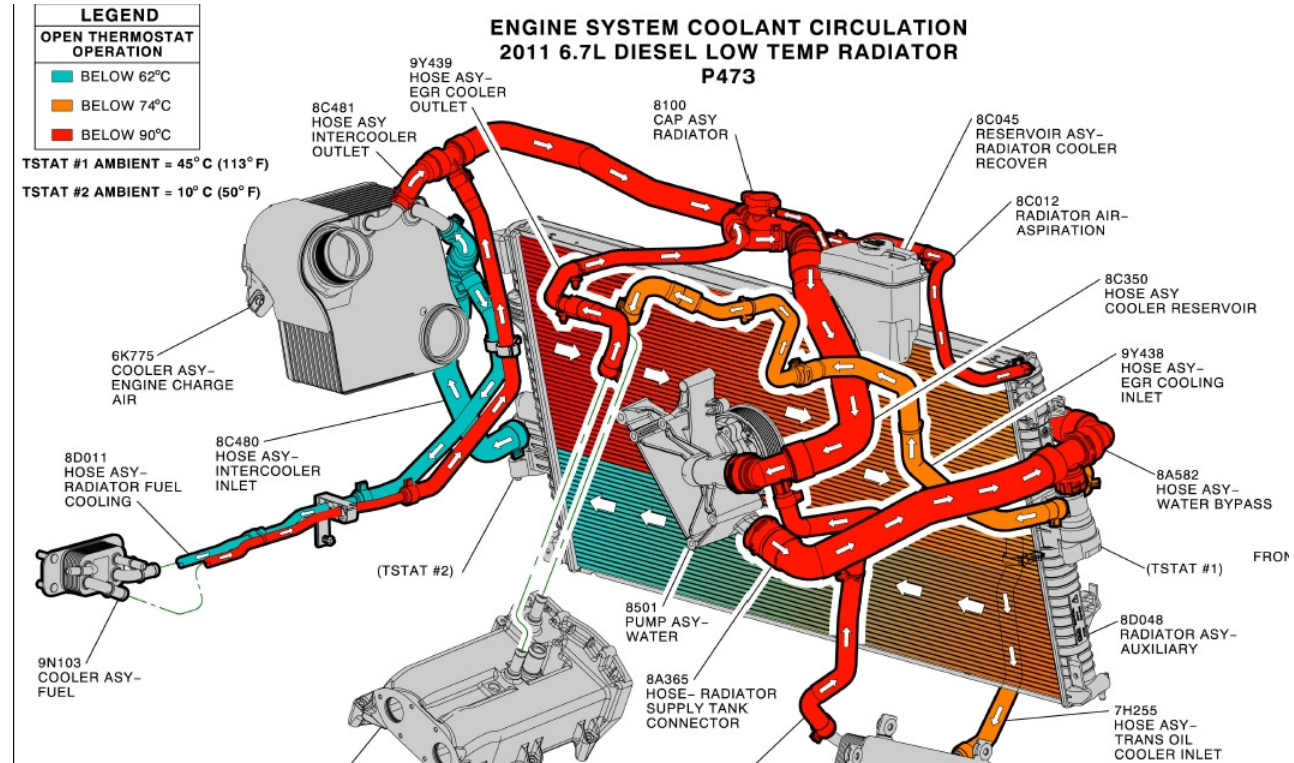

The rise check to detect a stuck ECT2 sensor is identical in function to the rise check used for the primary coolant loop. A minimum rise is expected over a calibratable amount of time,

ECT2 Rise Monitor:	
DTCs	P2183 - Engine Coolant Temperature Sensor 2 Circuit Range/Performance
Monitor Execution	Once per trip
Monitor Sequence	None
Sensors OK	ECT2,
Typical Monitoring Duration	5750 sec at -35C, 200 at 25C

Typical ECT2 Rise Monitor Entry Conditions:		
Entry condition	Minimum	Maximum
ECT2	-35 deg C	45 deg C
Engine Speed	400 rpm	

**Typical ECT2 RiseMonitor Malfunction Thresholds:**  
 within the time duration, must reach 25C



# COLD START EMISSION REDUCTION STRATEGY MONITORING

## Cold Start Emission Reduction System Monitor (Only 6.7L Pickup Applications)

The Post DOC temperature is monitored during a cold start for the CSER System Monitor. The modeled Post DOC temperature rise is compared to the measured Post DOC temperature rise. Specifically, the monitor compares the maximum temperature rises. An error is detected if the difference between the modeled and measured Post DOC maximum temperature rise is above a threshold.

An error will also be detected if the modeled vs. measured post DOC maximum temperature rise is above a threshold.

CSER System Check Operation:	
DTCs	P050E – Cold Start Engine Exhaust Temperatures Too Low
Monitor execution	During EOM3 Operation, once per drive cycle
Monitor Sequence	None
Sensors OK	TIA, EGT1, EGT2, MAF, MAP, P3
Monitoring Duration	300 seconds

Typical CSER System entry conditions:		
Entry condition	Minimum	Maximum
Engine in EOM3 Mode		
Ambient Temperature	0 deg C	
Ambient Pressure	75 kPa	
Engine Coolant Temperature		50 deg C
Engine Soak Time	6 hr	
Engine Speed	750 rpm	2300 rpm
Engine Load (Torque)	50 Nm	700 Nm
Percentage of time with speed/torque conditions met	50%	
No Sensor Errors		
No Error in Air Path, EGR, Boost, Fuel Path, Fuel Quantity, Timing and Pressure Monitors		

Typical CSER System malfunction thresholds:
Modeled vs. Measured Post DOC Temperature Rise > 45 deg C.

## Cold Start Emission Reduction Component Monitor

For all 2010 and subsequent model year vehicles that incorporate a specific engine control strategy to reduce cold start emissions, the OBD II system must monitor the components to ensure proper functioning. The monitor works by validating the operation of the components required to achieve the cold start emission reduction strategy, namely intake throttle and fuel balancing control. The 3.2L diesel does not use a cold start emission reduction strategy.

### Cold Throttle Valve Actuator Jammed Detection

Duplicate fault storage of throttle valve jammed detection exists, which can only set/clear in EOM3.

#### Cold Throttle Actuator Jammed Valve Check Operation:

DTCs	P02E1 – Diesel Intake Air Flow Control Performance,
Monitor execution	Continuous
Monitor Sequence	None
Monitoring Duration	5 seconds to register a malfunction

#### Typical Cold Throttle Actuator Jammed Valve Entry Conditions:

See Throttle Valve Actuator Jammed Detection

Engine Operating mode is EOM3

#### Typical Cold Throttle Jammed Valve Check (P02E1) Malfunction Thresholds:

A P02E1 is set in EOM3.

### Cold EGR Valve Actuator Jammed Detection

Duplicate fault storage of EGR valve jammed detection exists, which can only set/clear in EOM3.

#### EGR Valve Jammed Check Operation:

DTCs	P042E – Exhaust Gas Recirculation "A" Control Stuck Open
Monitor execution	Continuous
Monitor Sequence	None
Monitoring Duration	5 seconds to register a malfunction

#### Typical Actuator Jammed Valve Entry Conditions:

See EGR Valve Actuator Jammed Detection

Engine Operating mode is EOM3

#### Typical EGR Valve Jammed Check (P042E) Malfunction Thresholds:

A P042E is set in EOM3.

## Cold FBC (Only 6.7L Chassis Cert Applications)

Fuel Balancing Control is an algorithm designed to reduce differences in injected fuel quantity from cylinder to cylinder. The increase in crankshaft speed due to individual cylinder combustion events is measured. The amount of fuel injected to each cylinder is then adjusted up or down to minimize the difference in increase in crankshaft speed from cylinder to cylinder. The total amount of fuel injected among all cylinders remains constant. The Cold FBC runs exactly the same as the normal FBC monitor, only difference is that it will run during EOM3 instead of EOM0. The concept is shown in the graphic below.

### Basics of FBC

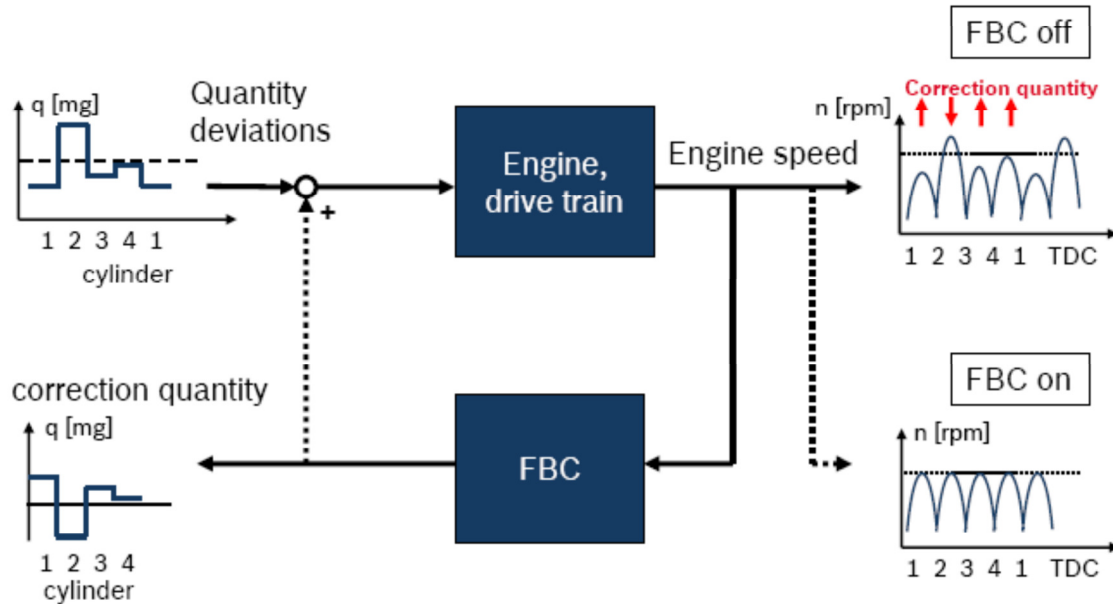

FBC operates in closed-loop control in an engine speed range of 500-3000 RPM, and a commanded injection quantity of 3.5 – 90 mg/stroke. The maximum allowed correction in fuel quantity for an individual cylinder is given by the following table.

**CSER Component Monitor: Cold FBC Control Limits:**

	Injection quantity requested before FBC correction (mg/stroke)		
	3.5	7.5	15
Max allowable FBC correction (mg/stroke):	4	7	14

When the current correction for a given cylinder exceeds 90% of the allowable correction for the current conditions, a code is set.

**CSER Component Monitor: Cold FBC Monitor Operation:**

DTCs	P0263 – Cylinder #1 Contribution/Balance P0266 – Cylinder #2 Contribution/Balance P0269 – Cylinder #3 Contribution/Balance P0272 – Cylinder #4 Contribution/Balance P0275 – Cylinder #5 Contribution/Balance P0278 – Cylinder #6 Contribution/Balance P0281 – Cylinder #7 Contribution/Balance P0284 – Cylinder #8 Contribution/Balance
Monitor Execution	P0263 – During EOM3 after a cold start P0266 – During EOM3 after a cold start P0269 – During EOM3 after a cold start P0272 – During EOM3 after a cold start P0275 – During EOM3 after a cold start P0278 – During EOM3 after a cold start P0281 – During EOM3 after a cold start P0284 – During EOM3 after a cold start
Monitor Sequence	None
Sensors OK	Crankshaft Position Sensor "A" Circuit (P0335) Crankshaft Position Sensor "A" Circuit Range/Performance (P0336)
Typical Monitoring Duration	7.5 sec

**Typical CSER Component Monitor: Cold FBC Monitor Entry Conditions:**

Entry condition	Minimum	Maximum
EOM3 Active		
Engine speed	500 rpm	3000 rpm
Injection quantity	3.5 mg/stroke	90 mg/stroke
Engine Temperature		
Barometric Pressure		
FBC wheel learn complete		

**Typical CSER Component Monitor: Cold FBC Monitor Malfunction Thresholds:**

If the current correction for the injector exceeds 90% of the allowable correction for current operation conditions, the code is set.

## Monitoring of High Pressure Fuel System during start

At engine start, starting problems can occur due to insufficient rail pressure. Monitor runs during engine cranking.

Monitor Summary:	
DTCs	P2291 - Injector Control Pressure Too Low - Engine Cranking
Monitor execution	During engine cranking
Monitor Sequence	None
Sensors OK	
Monitoring Duration	P2291- 20 Sec

Typical Entry Conditions:		
Entry condition	Minimum	Maximum
Fuel temperature	-50 Deg C	150 Deg C
Engine Coolant Downstream temperature	-50 Deg C	150 Deg C
Rail pressure		14000 kPa
Fuel tank level	-1 l	
Inertia Switch	Not set	

Typical Malfunction Thresholds:
If the rail pressure is less then 14000 kPa within the entry condition for 20 sec, fault is set.

## Crankcase Ventilation Monitor

The 6.7L diesel engine has a crankcase ventilation separator mounted on the driver side rocker cover, with a tube connecting the separator to the fresh air inlet of the turbocharger. The tube on the separator side has a tamper proof collar installed and is plastic welded to the separator. On the fresh air inlet side, a hall effect sensor is present, to detect connection to the inlet casting assembly. The tube cannot be disconnected on the separator side, and if it is disconnected from the inlet casting, a P04DB code is set, as sensor output drops below a calibrated threshold. There are also circuit range checks, P04E2 and P04E3 to detect shorts to ground, or short to battery/disconnected sensor, respectively.

### Crankcase Ventilation Monitor

DTCs	P04DB – Crankcase Ventilation System Disconnected P04E2 – Crankcase Ventilation Hose Connection Sensor Circuit Low P04E3 – Crankcase Ventilation Hose Connection Sensor Circuit High
Monitor Execution	Once per driving cycle – P04DB Continuous – P04E2, P04E3
Monitor Sequence	None
Sensors OK	P04DB - CVM (P04E2, P04E3)
Typical Monitoring Duration	2 sec

### Typical Crankcase Ventilation Monitor Entry Conditions:

Entry Condition	Minimum	Maximum
Coolant Temperature	70C	112 deg C
Ambient Temperature	-40C	70 deg C
Battery Voltage	9V	16.25V
Key is on		

### Crankcase Ventilation Monitor Disconnection Check Malfunction Thresholds:

P04DB – voltage below 2500 mv for 2 seconds (all other entry conditions met, heals if voltage rises above 3000mv)

### Crankcase Ventilation Monitor Circuit Check Malfunction Thresholds:

No minimum coolant, ambient temp entry conditions, continuous monitor:

P04E2 – voltage less than 1000 mv for 2 seconds

P01E3 – voltage greater than 4900 mv for 2 seconds

# Engine Sensors

## Air Temperature Rationality Test

An air temperature rationality test is performed once every drive cycle, after a long soak of 6 hours or greater. At key on, a temperature sample is taken of each of the following sensors: Ambient Air (AAT), Intake Air (IAT), Charge Air Cooler outlet (CACT1), EGR Cooler outlet (EGT COT), and Secondary Coolant Temperature (ECT2). Once a cold start has been confirmed, the temperature samples are compared against each other, and the temperature differences compared against a threshold. One sensor must fail plausibility with all four other sensors to set a fault for the sensor in question. If one or more sensors fail plausibility with three or fewer sensors, a general temperature plausibility fault is set. If a block heater has been detected, or if any sensor has been flagged for a pending signal range malfunction, the plausibility check is not performed.

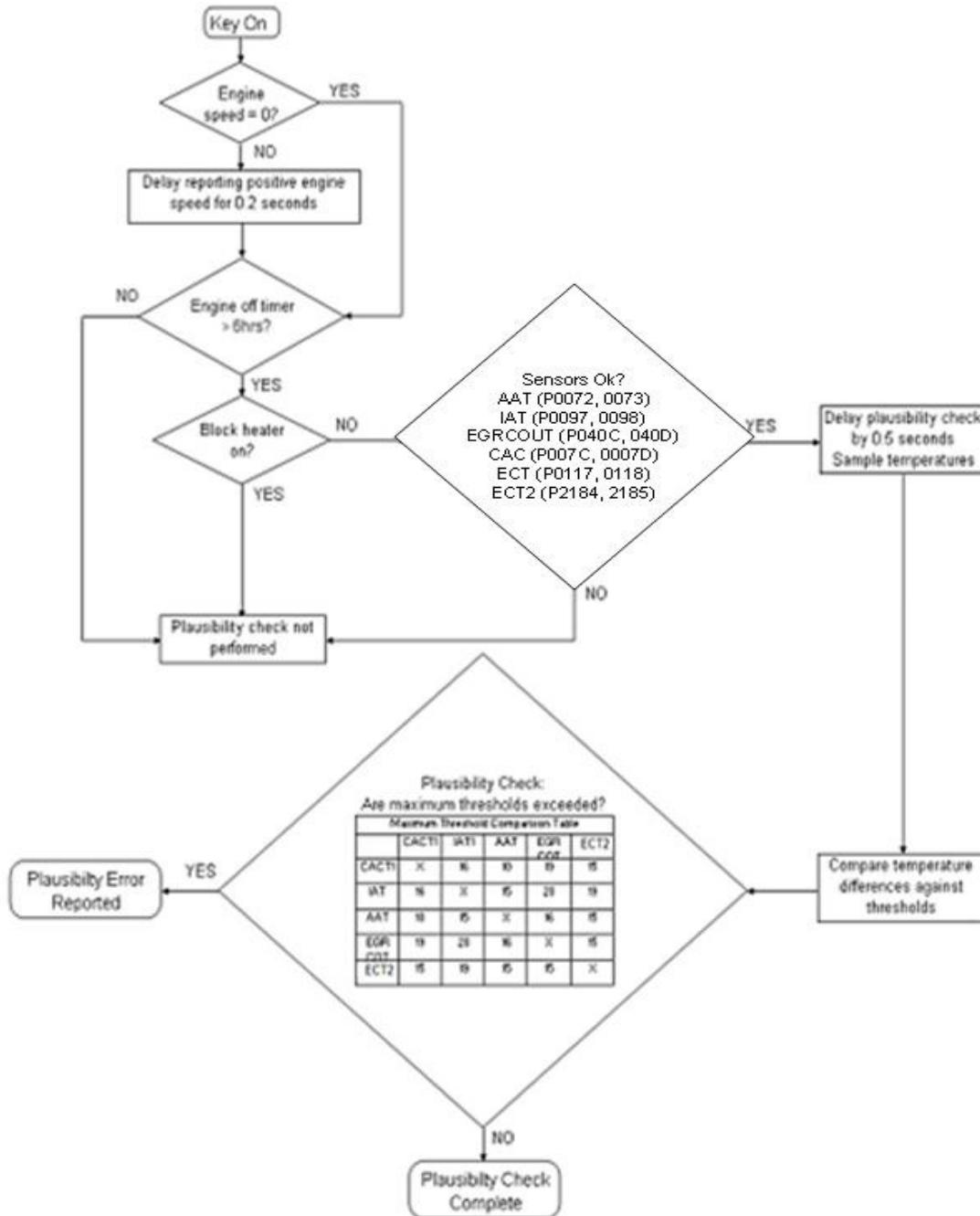

Figure : Air Temperature Plausibility Check Flow Chart

**Ambient Air Temperature (AAT) Sensor Circuit Check:**

DTCs	P0072 – Ambient Air Temperature Circuit Low P0073 – Ambient Air Temperature Sensor Circuit High
Monitor Execution	Continuous
Monitor Sequence	None
Sensors OK	Not applicable
Typical Monitoring Duration	2 sec.

**Typical Ambient Air Temperature Sensor Circuit Check Entry Conditions:**

Entry Condition	Minimum	Maximum
Battery Voltage	9 V	16.25 V
Key On		

**Typical Ambient Air Temperature Sensor Circuit Check Malfunction Thresholds:**

Voltage < 0.10 V (-40 deg C) or voltage > 4.99 V (108 deg C)

**Ambient Air Temperature Physical Range Check**

A physical range check of ambient air temperature is performed on each drive cycle. It compares the measured value of ambient air temperature to a threshold of 72 deg C, if the threshold is exceeded a fault is detected.

**Ambient Air Temperature (AAT) Sensor Physical Range Check:**

DTCs	P0070 - Ambient Air Temperature Circuit
Monitor Execution	Continuous
Monitor Sequence	None
Sensors OK	AAT (P0072, P0073),
Typical Monitoring Duration	4 seconds

**Typical Ambient Air Temperature Sensor Plausibility Check Entry Conditions:**

Entry Condition	Minimum	Maximum
Battery Voltage	9 V	16.25 V
Key On		

**Typical Ambient Air Temperature Sensor Plausibility Check Malfunction Thresholds:**

If AAT > 72 deg C for 4 seconds a fault is detected and the code is set.



**Ambient Air Temperature Rationality Check**

DTCs	P0071 – Ambient Air Temperature Sensor Range/Performance
Monitor Execution	Once per driving cycle. The check is disabled if a block heater is in use.
Monitor Sequence	None
Sensors OK	AAT (P0072, P0073), IAT1 (P0112, P0113), EGT11 (P0548, P0549), EGRCOT (P040D, P040C), ECT (P0117, P0118), EOT (P0197, P0198), CACT1 (P007C, P007D)
Typical Monitoring Duration	0.5 sec

**Typical Ambient Air Temperature Rationality Check Entry Conditions:**

Entry Condition	Minimum	Maximum
Engine Off Time	6 hrs	N/A
Engine coolant temperature	-35 deg C	121 deg C

**Typical Ambient Air Temperature Rationality Check Thresholds:**

AAT Rationality is confirmed against 4 other sensors (absolute temperature difference thresholds):

CACT1	10 deg C
IAT1	15 deg C
EGRCOT	16 deg C
ECT2	20 deg C

**Charge Air Cooler (CACT1) Sensor Circuit Check:**

DTCs	P007C – Charge Air Cooler Temperature Sensor Circuit Low P007D – Charge Air Cooler Temperature Sensor Circuit High
Monitor execution	Continuous
Monitor Sequence	None
Sensors OK	Not applicable
Typical Monitoring Duration	4 sec

**Typical Charge Air Cooler Temperature Sensor Circuit Check Malfunction Thresholds:**

Voltage < 0.092 V (161 deg C) or voltage > 4.90 V (-43 deg C)

**Charge Air Cooler Temperature (CACT1) Rationality Check:**

DTCs	P007B - Charge Air Cooler Temperature Sensor Circuit Range/Performance
Monitor Execution	Once per drive cycle. The check is disabled if a block heater is in use.
Monitor Sequence	None
Sensors OK	AAT (P0072, P0073), IAT1 (P0112, P0113), EGT11 (P0548, P0549), EGRCOT (P040D, P040C), ECT (P0117, P0118), EOT (P0197, P0198), CACT1 (P007C, P007D)
Typical Monitoring Duration	0.5 sec

**Typical Charge Air Cooler Temperature Rationality Check Entry Conditions:**

Entry Condition	Minimum	Maximum
Engine Off Time	6 hrs	
Coolant Temp	-35 deg C	121 deg C

**Typical Charge Air Cooler Temperature Functional Thresholds:**

CACT1 Rationality is confirmed against 4 other sensors (absolute temperature difference thresholds):

AAT	10 deg C
IAT1	16 deg C
EGRCOT	19 deg C
ECT2	20 deg C

**Intake Air Temperature (IAT) Sensor Circuit Check:**

DTCs	P0112 - Intake Air Temperature Sensor Circuit Low P0113 - Intake Air Temperature Sensor Circuit High
Monitor Execution	Continuous
Monitor Sequence	None
Sensors OK	Not applicable
Typical Monitoring Duration	4 sec.

**Typical Intake Air Temperature Sensor Circuit Check Malfunction Thresholds:**

Voltage < 0.10 volts (137 deg C) or voltage > 4.91 volts (-25 deg C)

**Intake Air Temperature Rationality Check**

DTCs	P0111 – Temperature Sensor Circuit Range/Performance
Monitor Execution	Once per drive cycle. The check is disabled if a block heater is in use.
Monitor Sequence	None
Sensors OK	AAT (P0072, P0073), IAT1 (P0112, P0113), EGT11 (P0548, P0549), EGRCOT (P040D, P040C), ECT (P0117, P0118), EOT (P0197, P0198), CACT1 (P007C, P007D)
Typical Monitoring Duration	0.5 sec

**Typical Intake Air Temperature Rationality Check Entry Conditions:**

Entry Condition	Minimum	Maximum
Engine Off Time	6 hrs	
Coolant Temp	-35 deg C	121 deg C

**Typical Intake Air Temperature Functional Thresholds:**

IAT Rationality is confirmed against 4 other sensors (absolute temperature difference thresholds):

AAT	15 deg C
CACT1	16 deg C
EGTCOT	20 deg C
ECT2	20 deg C

**EGR Cooler Downstream Temperature (EGR COT) Sensor Circuit Check:**

DTCs	P040C – Exhaust Gas Recirculation Temperature Sensor Circuit Low P040D – Exhaust Gas Recirculation Temperature Sensor Circuit High
Monitor execution	Continuous
Monitor Sequence	None
Sensors OK	Not applicable
Typical Monitoring Duration	3 sec.

**Typical EGR Cooler Downstream Temperature Sensor Circuit Check Malfunction Thresholds:**

Voltage < 0.10 volts (961 deg C) or voltage > 4.90 volts (-46 deg C)

**EGR Cooler Downstream Temperature Rationality Check**

DTCs	P040B – Exhaust Gas Recirculation Temperature Sensor Circuit Range/Performance
Monitor Execution	Once per drive cycle. The check is disabled if a block heater is in use.
Monitor Sequence	None
Sensors OK	AAT (P0072, P0073), IAT1 (P0112, P0113), EGT11 (P0548, P0549), EGRCOT (P040D, P040C), ECT (P0117, P0118), EOT (P0197, P0198), CACT1 (P007C, P007D)
Typical Monitoring Duration	0.5 sec

**Typical EGR Cooler Downstream Temperature Rationality Check Entry Conditions:**

Entry Condition	Minimum	Maximum
Engine Off Time	6 hrs	
Coolant Temp	-35 deg C	121 deg C

**Typical EGR Cooler Downstream Temperature Functional Thresholds:**

EGRCOT Rationality is confirmed against 4 other sensors (absolute temperature difference thresholds):

AAT	16 deg C
CACT1	19 deg C
IAT1	20 deg C
ECT2	20 deg C

**Typical EGR Temperature Sensor #2 Circuit Check Malfunction Thresholds:**

Voltage < 0.10 volts (961 deg C) or voltage > 4.90 volts (-46 deg C)

**EGR Temperature Sensor #2 Rationality Check**

DTCs	P041B – Exhaust Gas Recirculation Temperature Sensor “B” Circuit Range/Performance
Monitor Execution	Once per drive cycle. The check is disabled if a block heater is in use.
Monitor Sequence	None
Sensors OK	AAT (P0072, P0073), IAT1 (P0112, P0113), EGT11 (P0548, P0549), EGRCOT (P040D, P040C), ECT (P0117, P0118), EOT (P0197, P0198), CACT1 (P007C, P007D)
Typical Monitoring Duration	0.5 sec

**Typical EGR Temperature Sensor #2 Rationality Check Entry Conditions:**

Entry Condition	Minimum	Maximum
Engine Off Time	6 hrs	
Coolant Temp	-35 deg C	121 deg C

**Secondary Engine Coolant Temperature (ECT2) Sensor Circuit Check:**

DTCs	P2184 - Engine Coolant Temperature Sensor 2 Circuit Low P2185 - Engine Coolant Temperature Sensor 2 Circuit High
Monitor execution	Continuous
Monitor Sequence	None
Sensors OK	Not Applicable
Typical Monitoring Duration	2 sec.

**Typical Secondary Engine Coolant Temperature Sensor Circuit Check Entry Conditions:**

Entry condition	Minimum	Maximum
Key On		
Battery Voltage	9 V	16.25 V

**Typical Secondary Engine Coolant Temperature Sensor Circuit Check Malfunction Thresholds:**

Voltage < 0.10 (163 deg C) volts or voltage > 4.91 volts (-44 deg C)

**Secondary Engine Coolant Temperature Rationality Check**

DTCs	P2182 – Engine Coolant Temperature Sensor 2 Circuit
Monitor Execution	Once per drive cycle. The check is disabled if a block heater is in use.
Monitor Sequence	None
Sensors OK	AAT (P0072, P0073), IAT1 (P0112, P0113), EGT11 (P0548, P0549), EGRCOT (P040D, P040C), ECT (P0117, P0118), EOT (P0197, P0198), CACT1 (P007C, P007D)
Typical Monitoring Duration	0.5 sec

**Typical Secondary Engine Coolant Temperature Rationality Check Entry Conditions:**

Entry Condition	Minimum	Maximum
Engine Off Time	6 hrs	
Coolant Temp	-35 deg C	121 deg C

**Typical Secondary Engine Coolant Temperature Functional Thresholds:**

ECT2 Rationality is confirmed against 4 other sensors (absolute temperature difference thresholds):

AAT	20 deg C
CACT1	20 deg C
IAT1	20 deg C
EGRCOT	20 deg C

## Barometric Pressure and Manifold Absolute Pressure

Barometric Pressure (BARO) Sensor Circuit Check:	
DTCs	P2227 – Barometric Pressure Sensor "A" Circuit Range/Performance P2228 – Barometric Pressure Circuit Low Input P2229 – Barometric Pressure Circuit High Input
Monitor Execution	Continuous
Monitor Sequence	None
Sensors OK	Not applicable
Typical Monitoring Duration	P2227 – 1 sec P2228, P2229 –.5 sec.

Typical Barometric Pressure Sensor Circuit Check Entry Conditions:		
Entry condition	Minimum	Maximum
Battery voltage (IVPWR)	9 V	16.25 V

Typical Barometric Pressure Sensor Circuit Check Malfunction Thresholds:	
P2227	– Observed pressure less than 50 kPa
P2228	- Voltage less than 0.25 V. (6.3 kPa)
P2229	- Voltage greater than 4.85 V. (115 kPa)

Manifold Absolute Pressure (MAP) Sensor Circuit Check:	
DTCs	P0107 - Manifold Absolute Pressure/BARO Sensor Low Input P0108 - Manifold Absolute Pressure/BARO Sensor High Input
Monitor Execution	Continuous
Monitor Sequence	None
Sensors OK	Not applicable
Typical Monitoring Duration	P0107, P0108 - 2 sec.

Typical Manifold Absolute Pressure Sensor Circuit Check Entry Conditions:		
Entry condition	Minimum	Maximum
Key-on		
Battery voltage (IVPWR)	9 V	16.25 V

Typical Manifold Absolute Pressure Sensor Circuit Check Malfunction Thresholds:	
P0107	– Voltage less than .1 V (50 kPa)
P0108	– Voltage greater than 4.745 V (390 kPa)

**Manifold Absolute Pressure (MAP) Sensor Plausibility Check:**

DTCs	P0107 - Manifold Absolute Pressure/BARO Sensor Low Input P0236 - Turbocharger/Supercharger Boost Sensor "A" Circuit Range/Performance
Monitor Execution	Continuous
Monitor Sequence	None
Sensors OK	Not applicable
Typical Monitoring Duration	2 sec.

**Typical Manifold Absolute Pressure Sensor Circuit Check Entry Conditions:**

Entry condition	Minimum	Maximum
Key-on		
Battery voltage (IVPWR)	9 V	16.25 V

**Typical Manifold Absolute Pressure Sensor Circuit Check Malfunction Thresholds:**

P0236 – if MAP > 3.5 bar absolute, this fault sets.

**Manifold Absolute Pressure (MAP) / Barometric Pressure (BARO) Rationality Check:**

DTCs	P0069 – MAP/BARO Correlation
Monitor Execution	Once per trip
Monitor Sequence	None
Sensors OK	BARO (P2228, P2229), MAP (P0107, P0108)
Typical Monitoring Duration	1.5 sec.

**Typical MAP / BARO Rationality Check Entry Conditions:**

Entry condition	Minimum	Maximum
P0069 - MAP / BARO Correlation:		
Key-on		
Battery voltage (IVPWR)	9 V	16.25 V
Engine Speed (N)	0 rpm	437.5 rpm

**Typical MAP / BARO Rationality Check Malfunction Thresholds:**

P0069 - The difference between MAP and BARO is greater than 4.5 kPa, or less than -8 kPa.

## Turbine Upstream Pressure Sensor Plausibility Checks

The turbine upstream pressure sensor has two plausibility checks to determine if the sensor is operating correctly. The first check looks for an offset in the turbine upstream pressure sensor when the engine is not running. This check compares the absolute value of the difference between the measured turbine upstream pressure and the measured environmental pressure under specific entry conditions. If the pressure difference exceeds the threshold, for a predetermined amount of time while the entry conditions are met, a fault is set.

<b>Turbine Upstream Pressure Sensor Offset Plausibility Check Operation:</b>	
DTCs	P0471– Exhaust Pressure Sensor "A" Circuit Range / Performance
Monitor execution	Continuous in with engine off.
Monitor Sequence	None
Monitoring Duration for stuck midrange	1.0 seconds to register a malfunction once entry conditions are met.

<b>Turbine Upstream Pressure Sensor Offset Entry Conditions</b>		
<b>Entry Condition:</b>	<b>Minimum</b>	<b>Maximum</b>
Turbine Upstream Pressure Sensor is not Frozen		
Ambient Pressure	74.5 kPa	
Ambient Air Temperature	5 deg C	
Coolant Temperature	5 deg C	
Engine Speed		0 rpm
Engine Off Time		10 sec.
No Turbine Upstream Pressure Sensor		

<b>Typical Upstream Turbine Pressure Sensor Plausibility Check Malfunction Thresholds:</b>
Turbine Pressure Sensor – Ambient Pressure Sensor   > 7.5 kPa



The second check compares the measured pressure upstream of the turbine to a model of the pressure upstream of the turbine under specific entry conditions. If the difference between the measured and modeled pressure is greater than a threshold, for a predetermined amount of time while the entry conditions are met, a fault is set.

<b>Turbine Upstream Pressure Sensor -Model Plausibility Check Operation:</b>	
DTCs	P0474– Exhaust Pressure Sensor "A" Circuit Intermittent / Erratic
Monitor execution	Continuous when entry conditions are met.
Monitor Sequence	None
Monitoring Duration for stuck midrange	2.0 seconds to register a malfunction once entry conditions are met.

<b>Turbine Upstream Pressure Sensor Offset Entry Conditions</b>		
<b>Entry Condition:</b>	<b>Minimum</b>	<b>Maximum</b>
Turbine Upstream Pressure Sensor is not Frozen		
Coolant Temperature	50 deg C	
Engine Speed	1300 rpm	2400 rpm
Engine Torque	500 Nm	1400 Nm
Ambient Air Temperature	5 deg C	
Ambient Pressure	74.5 kPa	
Modeled Exhaust Pressure	147.5 kPa	620.0 kPa
Air Flow Gradient		140 g/s/step

<b>Typical Upstream Turbine Pressure Sensor Plausibility Check Malfunction Thresholds:</b>
(Turbine Pressure Model – Turbine Pressure Sensor) > 90.0 kPa

## Upstream Turbine Pressure Sensor Signal Range Check

Reductant Pressure Sensor Open/Short Check Operation:	
DTCs	P0472 - Exhaust Pressure Sensor "A" Circuit Low P0473 - Exhaust Pressure Sensor "A" Circuit High
Monitor execution	Continuous
Monitor Sequence	none
Sensors OK	none
Monitoring Duration	2 seconds to register a malfunction

Typical Reductant Pressure Sensor Check Malfunction Thresholds:
Pressure sensor voltage < 0.100 volts or Pressure sensor voltage > 4.8 volts

## EGR Valve Position Sensor

EGR Valve Position Sensor Check Operation:	
DTCs	P0405 (EGR Sensor "A" Circuit Low) P0406 (EGR Sensor "A" Circuit High)
Monitor execution	continuous
Monitor Sequence	none
Sensors OK	not applicable
Monitoring Duration	3 seconds to register a malfunction

Typical EGR Valve position sensor check malfunction thresholds (P0405,P0406):
Voltage < 0.30 volts or Voltage > 4.70 volts

## Throttle Position Sensor

Analog inputs checked for opens or shorts by monitoring the analog -to-digital (A/D) input voltage.

Throttle Position Sensor Check Operation:	
DTCs	P02E9 (Diesel Intake Air Flow Position Circuit High), P02E8 (Diesel Intake Air Flow Position Circuit Low).
Monitor execution	continuous
Monitor Sequence	none
Sensors OK	not applicable
Monitoring Duration	3 seconds to register a malfunction

Typical TP sensor check malfunction thresholds (P02E8,P02E9):
Voltage < 0.08 volts or Voltage > 4.92 volts

## EGR Downstream Temperature Sensor Dynamic Plausibility Check

Dynamic plausibility of the EGR downstream temperature sensor for the 6.7L diesel is checked using the EGR cooler monitor.

### Engine Coolant & Engine Oil Correlation

The engine coolant temperature sensor reading and engine oil temperature sensor readings are tested for plausibility once per drive cycle after a long soak (6hrs or more). The values of the coolant and oil temperature sensor readings are recorded at start up. Once it has been determined that the enable conditions have been achieved, upper and lower thresholds are determined based on the engine-off time. The difference of the initial oil and coolant temperatures are compared to this threshold. If the lower threshold is not achieved, a fault is reported. If the lower threshold is met, but the upper threshold is not achieved and a block heater is not in use, a fault is reported. If a block heater is detected and the difference is greater than 40C, a fault is reported.

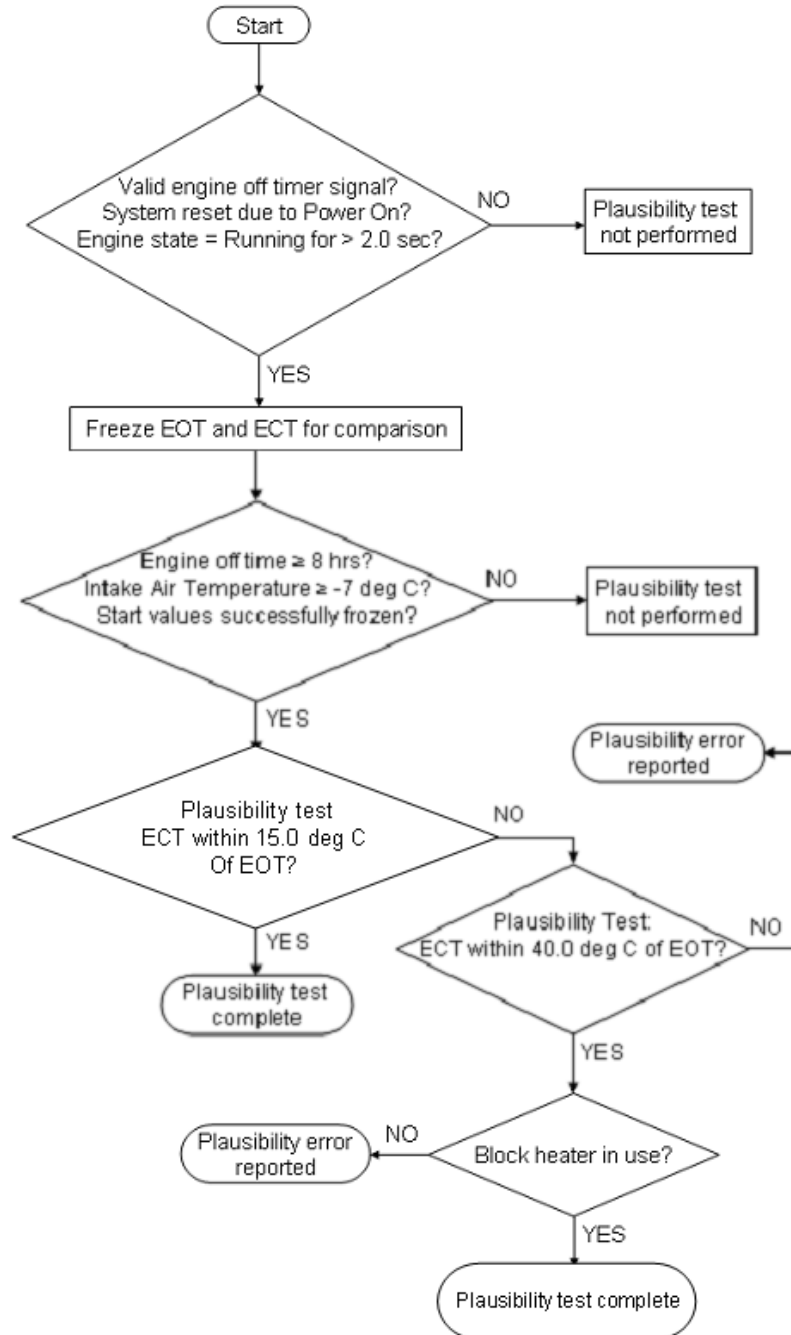

ECT/EOT Plausibility Correlation Test Flow Chart

**Engine Coolant Temperature (ECT) Sensor Circuit Check:**

DTCs	P0117 - Engine Coolant Temperature Sensor Circuit Low P0118 - Engine Coolant Temperature Sensor Circuit High
Monitor execution	Continuous
Monitor Sequence	None
Sensors OK	Not Applicable
Typical Monitoring Duration	2 sec.

**Typical Engine Coolant Temperature Sensor Circuit Check Entry Conditions:**

Entry condition	Minimum	Maximum
Key On		
Battery Voltage	9 V	16.25 V

**Typical Engine Coolant Temperature Sensor Circuit Check Malfunction Thresholds:**

Voltage < 0.10 (163 deg C) volts or voltage > 4.91 volts (-44 deg C)

**Engine Coolant Temperature Rationality Check**

DTCs	P012F – Engine Coolant Temperature / Engine Oil Temperature Correlation
Monitor Execution	Once per drive cycle.
Monitor Sequence	None
Sensors OK	AAT (P0072, P0073), IAT1 (P0112, P0113), ECT (P0117, P0118), EOT (P0197, P0198)
Typical Monitoring Duration	Immediate when conditions exist

**Typical Engine Coolant Temperature Rationality Check Entry Conditions:**

Entry Condition	Minimum	Maximum
Engine Off Time	6 hrs	
Intake Air Temp	-7 deg C	
Engine "Running" Time	2 sec	

**Typical Engine Coolant Temperature Functional Thresholds:**

ECT Rationality is confirmed against EOT:

Absolute Temperature Difference	15 deg C
---------------------------------	----------

**Engine Coolant Temperature in range Rationality Check**

DTCs	P0196 –Engine Oil Temperature Sensor Range/Performance
Monitor Execution	Once per drive cycle.
Monitor Sequence	None
Sensors OK	ECT (P0117, P0118), EOT (P0197, P0198)
Typical Monitoring Duration	Immediate when conditions exist

**Typical Engine Coolant Temperature Rationality Check Entry Conditions:**

Entry Condition	Minimum	Maximum
Engine Off Time	6 hrs	
Engine Coolant Temp	70C	

**Typical Engine Coolant Temperature Functional Thresholds:**

ECT Rationality is confirmed against EOT:

Absolute Temperature Difference	35 deg C
---------------------------------	----------

**Engine Oil Temperature (EOT) Sensor Circuit Check:**

DTCs	P0197 - Engine Oil Temperature Sensor Circuit Low P0198 - Engine Oil Temperature Sensor Circuit High
Monitor execution	Continuous
Monitor Sequence	None
Sensors OK	Not Applicable
Typical Monitoring Duration	2 sec.

**Typical Engine Oil Temperature Sensor Circuit Check Entry Conditions:**

Entry condition	Minimum	Maximum
Key On		
Battery Voltage	9 V	16.25 V

**Typical Engine Oil Temperature Sensor Circuit Check Malfunction Thresholds:**

Voltage &lt; 0.10 (163 deg C) volts or voltage &gt; 4.91 volts (-44 deg C)

**Engine Coolant System Leak Check:**

DTCs	P2560 - Engine Coolant Level Low
Monitor execution	Continuous
Monitor Sequence	None
Sensors OK	ECT and OIL temp.
Typical Monitoring Duration	5 sec.

**Typical Engine Oil Temperature Sensor Circuit Check Entry Conditions:**

Entry condition	Minimum	Maximum
Engine Oil Temp	70C	

**Typical Engine Oil Temperature Sensor Circuit Check Malfunction Thresholds:**

Oil Temperature is greater than coolant temperature by 50C

# Cam and Crank Sensor

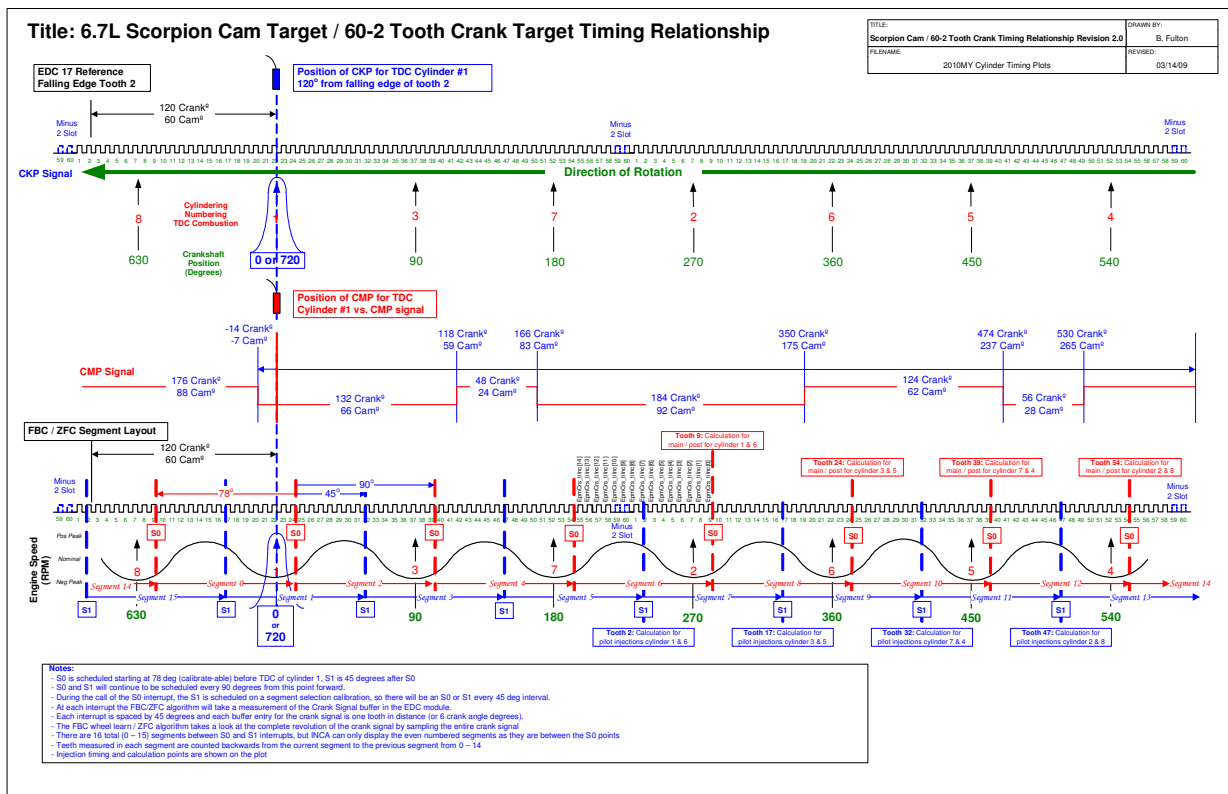

Camshaft and Crankshaft Sensor Monitor Operation:	
DTCs	P0016 – Crankshaft Position - Camshaft Position Correlation (Bank 1 Sensor A) P0315 – Crankshaft Position System Variation Not Learned P0335 – Crankshaft Position Sensor "A" Circuit P0336 – Crankshaft Position Sensor "A" Circuit Range/Performance P0340 – Camshaft Position Sensor "A" Circuit (Bank 1 or single sensor) P0341 – Camshaft Position Sensor "A" Circuit Range/Performance (Bank 1 or single sensor)
Monitor Execution	P0016 – Continuous P0315 – Continuous P0335 – Continuous P0336 – Continuous P0340 – Continuous P0341 – Continuous
Monitor Sequence	None
Sensors OK	P0016 – Sensor Supply Voltage 1 (P06A6), Sensor Supply Voltage 2 (P06A7) P0315 – Sensor Supply Voltage 1 (P06A6), Crankshaft Sensor (P0335, P0336) P0335 – Sensor Supply Voltage 1 (P06A6) P0336 – Sensor Supply Voltage 1 (P06A6) P0340 – Sensor Supply Voltage 2 (P06A7) P0341 – Sensor Supply Voltage 2 (P06A7)
Typical Monitoring Duration	P0016 – 3.6 sec, P0315 – 5000 sec of overrun/decel fuel shut-off P0335 – 1.8 sec, P0336 – 1.8 sec, P0340 – 3 sec, P0341 – 1.2 sec

**Typical Camshaft and Crankshaft Sensor Monitor Entry Conditions:**

Entry condition	Minimum	Maximum
P0016 – Engine running or cranking		
P0315 – Overrun/decel fuel shut-off		
P0335 – Engine running or cranking		
P0336 – Engine running or cranking		
P0340 – Engine running or cranking		
P0341 – Engine running or cranking		

**Typical Camshaft Sensor Monitor Malfunction Thresholds:**

P0016 – If the location of the gap on the crankshaft sensor wheel occurs at a location on the camshaft sensor wheel that is more than 6 degrees from the expected location for two detection attempts, the code is set

P0315 – If after 5000 total seconds of overrun/decel fuel shut-off, the system has been unable to learn crankshaft wheel deviation corrections, the code is set

P0335 – If no signal is detected from the crankshaft sensor, the code is set

P0336 – If the gap in the 60-2 tooth wheel is not detected for three revolutions, the code is set

P0340 – If no signal is detected from the camshaft sensor, the code is set

P0341 – If the segment profile detected does not match the segment profile shown in the figure above, the code is set



## Mass Air Meter

The 6.7L engine utilizes a frequency-based hot film air meter. The digital output varies its period to indicate a change in mass air flow. If the period is outside of a specified range, a fault is detected and the appropriate P-code is set.

<b>MAF Sensor Circuit Check:</b>	
DTCs	P0100 – Mass or Volume Air Flow “A” Circuit P0102 – Mass or Volume Air Flow “A” Circuit Low P0103 – Mass or Volume Air Flow “A” Circuit High
Monitor Execution	Continuous
Monitor Sequence	None
Sensors OK	Not applicable
Typical Monitoring Duration	P0100 – 1.5 sec P0102 – 2 sec P0103 – 2 sec

<b>MAF Sensor Circuit Check Entry Conditions:</b>		
Entry condition	Minimum	Maximum
Battery voltage	9 V	16.25 V
Key on		

<b>MAF Sensor Circuit Check Malfunction Thresholds:</b>
P0100 – hard coded, not visible in software
P0102 – period less than 62 us
P0103 – period greater than 4000 us

## MAF Rationality Check

A rationality check of the mass air flow sensor is performed each time an air mass adaption (AMA) executes. AMA adapts at two points- one at idle, the other at a specific speed/load. The ratio between the mass air flow and the reference mass air flow is calculated with the EGR valve commanded to the closed position. The release of this plausibility check occurs under strict engine operating and environmental conditions to minimize the affect of outside influences on mass air flow. At each AMA event, the corrected value is stored for each point. These stored values are compared to a threshold, if the stored values are greater than a threshold a fault is detected, as the air meter has drifted outside of its nominal operating range. In addition to the stored values, the corrected airflow is compared to directly to the modeled airflow during AMA. If the ratio of the corrected airflow and the modeled airflow is less than the threshold, a fault is detected. The following figure outlines the strategy for the rationality checks.

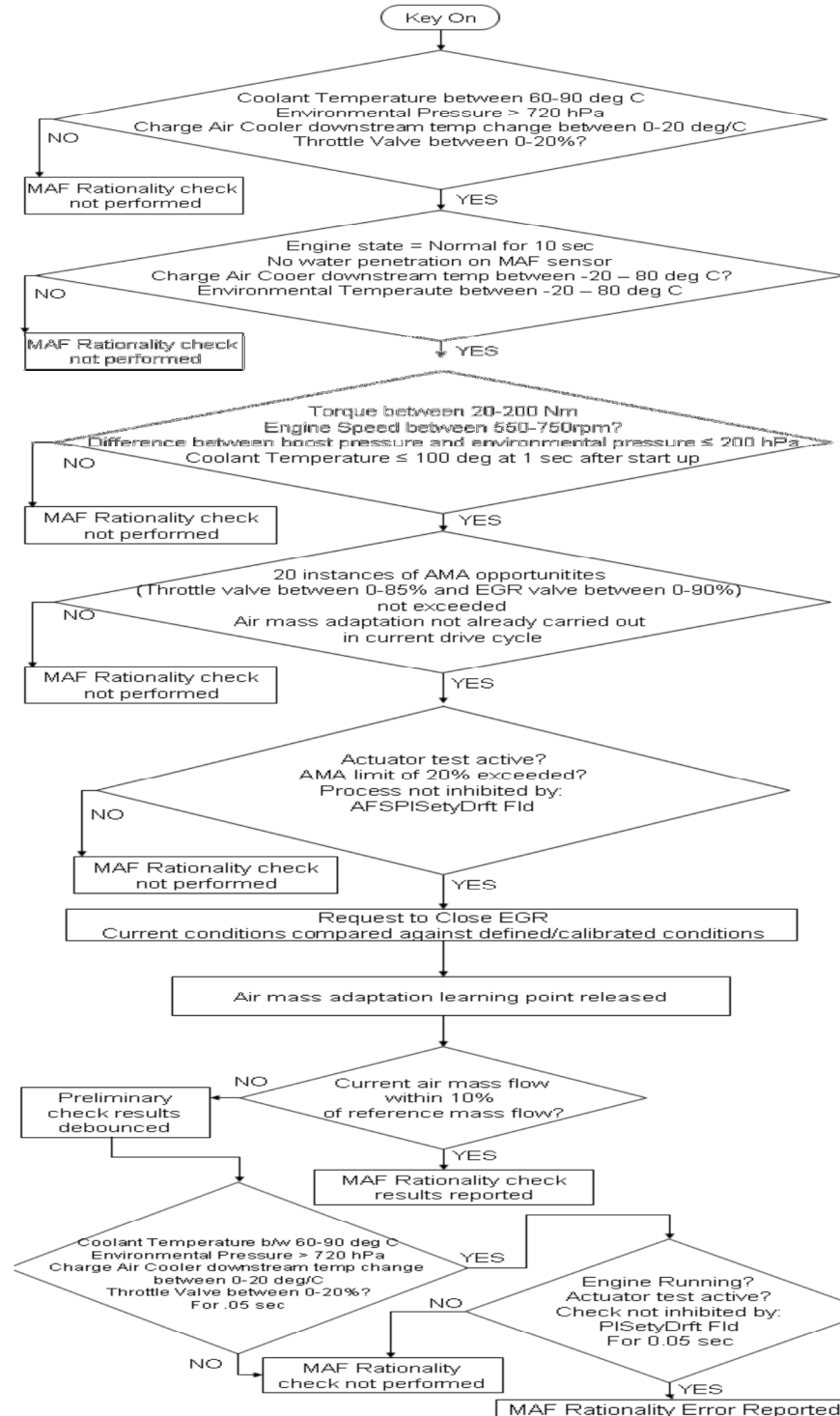

**Mass Air Flow Sensor Functional Check Operation:**

DTCs	<p>P2073 – Manifold Absolute Pressure/Mass Air Flow - Throttle Position Correlation at Idle</p> <p>P2074 – Manifold Absolute Pressure/Mass Air Flow - Throttle Position Correlation at Higher Load</p> <p>P00BC – Mass or Volume (MAF/VAF) Air Flow “A” Circuit Range/Performance – Air Flow Too Low</p> <p>P0101 – Mass or Volume (MAF/VAF) Air Flow Sensor “A” Circuit Range Performance</p>
Monitor Execution	Once per drive cycle
Monitor Sequence	None.
Sensors OK	MAF (P0100, P0101, P0102), BARO (P2228, P2229), EGRP (P0405, P0406, P0404, P0042E, P042F, P1335),
Typical Monitoring Duration	5 Seconds

**Typical Mass Air Flow Sensor Functional Check Entry Conditions:**

Entry condition	Minimum	Maximum
Barometric Pressure	74.5 kPa	110 kPa
Engine Coolant Temperature	70 deg C	112 deg C
Throttle Valve	0%	20%
CAC Downstream Temperature	-20 deg C	80 deg C
Ambient Air Temperature	-20 deg C	80 deg C
Time engine running Normal	10 seconds	
No Water Penetration Detected in Sensor		
Engine Coolant Temperature at 1 second after key on		100 deg C
Difference in Barometric Pressure versus Pressure in Induction Volume		20 kPa
Engine Torque	20 Nm	200 Nm
Engine Speed	500 rpm	760 rpm

**Typical Mass Air Flow Sensor Functional Check Malfunction Thresholds:**

P2073, P2074 - If the final AMA stored value in either the idle or higher load cell is greater than 20% or less than -20%, a fault is detected and the appropriate P-code is set.

P00BC - Corrected measured airflow / Modeled airflow < 0.7

P0101 - Corrected measured airflow / Modeled airflow < 0.7

P2074 – If the algorithm cannot learn a stable value for AMA within 10 learning events, this code is set.

## Air Path Leakage Check

Similar to the mass air flow sensor functional check diagnostics, a rationality check of the mass air flow sensor is performed each time an air mass adaption (AMA) executes which is used to detect instantaneous problems with the air path. At idle, the ratio between the mass air flow and the reference mass air flow is calculated with the EGR valve in the closed position. This ratio is compared against a threshold once AMA has been released. The release of this plausibility check occurs under strict engine operating and environmental conditions to minimize the affect of outside influences on mass air flow. The ratio has an upper and lower limit, and the monitor runs once per drive cycle. A ratio too high indicates a post-turbocharger compressor air path leak, while a ratio too low indicates an EGR valve that is no longer sealing effectively.

Air Path Leakage Check Operation:	
DTCs	P00BC – Mass or Volume (MAF/VAF) Air Flow A Circuit Range/Performance – Air Flow Too Low  P0101 – Mass or Volume (MAF/VAF) Air Flow Sensor “A” Circuit Range Performance  P00BD - Mass or Volume (MAF/VAF) Air Flow A Circuit Range/Performance – Air Flow Too High
Monitor Execution	Once per drive cycle
Monitor Sequence	None.
Sensors OK	MAF (P0100, P0101, P0102), BARO (P2228, P2229), EGRP (P0405, P0406, P0404, P0042E, P042F, P1335),
Typical Monitoring Duration	3 seconds

Typical Air Path Leakage Check Entry Conditions:		
Entry condition	Minimum	Maximum
Barometric Pressure	74.5 kPa	110 kPa
Engine Coolant Temperature	70 deg C	111 deg C
Throttle Valve	0%	20%
CAC Downstream Temperature	-20 deg C	80 deg C
Ambient Air Temperature	-20 deg C	80 deg C
Time engine running Normal	10 seconds	
No Water Penetration Detected in Sensor		
Engine Coolant Temperature at 1 second after key on		111 deg C
Difference in Barometric Pressure versus Pressure in Induction Volume		20 kPa
Engine Torque	20 Nm	200 Nm
Engine Speed	500 rpm	760 rpm
Turbocharger Position	75%	
EGR Valve Position		5.1%

Typical Air Path Leakage Check Malfunction Thresholds:
If the ratio between modeled airflow and measured uncorrected airflow is greater than 1.18 or less than .76 a fault is detected and the appropriate P-code is set.

**Mass Air Flow Sensor Plausibility Check Operation:**

DTCs	P1102 – Mass Air Flow Sensor In Range But Lower Than Expected P1103 – Mass Air Flow Sensor In Range But Higher Than Expected
Monitor Execution	Continuous
Monitor Sequence	None.
Sensors OK	MAF (P0100, P0101, P0102), BARO (P2228, P2229), EGRP (P0405, P0406, P0404, P0042E, P042F, P1335),
Typical Monitoring Duration	10 seconds

**Typical Mass Air Flow Sensor Plausibility Check Entry Conditions:**

Entry condition	Minimum	Maximum
Barometric Pressure	75 kPa	110 kPa
Engine Coolant Temperature	70 deg C	121 deg C
Ambient Air Temperature	-20 deg C	80 deg C
Time engine running Normal	5 seconds	
Key On		

**Typical Mass Air Flow Sensor Plausibility Check Malfunction Thresholds:**

If Mass Air Flow is greater than the maximum AFS threshold map,, or less than the minimum AFS threshold map for 10 seconds, a fault is detected and a P-code is set.

**Minimum AFS Threshold Map**

RPM	400	600	1000	1500	2000	2500	3000	3500
Airflow	0	25	100	130	130	150	180	210

**Maximum AFS Threshold Map**

RPM	600	750	1000	1500	2000	2500	3000	3500
Airflow	300	400	540	850	1100	1350	1550	1550

## Turbocharger/Boost Sensor

### Turbocharger/Boost Feedback Check Operation:

DTCs	P0237 - Turbocharger/Supercharger Boost Sensor "A" Circuit Low P0238 - Turbocharger/Supercharger Boost Sensor "A" Circuit High P0047 - Turbocharger/Supercharger Boost Control "A" Circuit Low P0048 - Turbocharger/Supercharger Boost Control "A" Circuit High
Monitor Execution	Continuous
Monitor Sequence	None
Sensors OK	none
Typical Monitoring Duration	5 seconds

### Typical Turbocharger/Boost Feedback Check Entry Conditions:

Entry condition	Minimum	Maximum
Battery voltage	9 v	14 v

### Typical Turbocharger/Boost Feedback Check Malfunction Thresholds:

P0237: sensor voltage < 0.2 v  
P0238: sensor voltage > 4.8 v  
P0047: Injector short circuit detected by IC internal logic  
P0048: Injector open circuit detected by IC internal logic logic

## DEF Pressure Sensor

The DEF pressure control system uses the measured DEF pressure in a feedback control loop to achieve the desired DEF pressure. The DEF injection algorithm uses actual DEF pressure in its computation of DEF injector pulse width.

The DEF sensor is a gauge sensor. Its atmospheric reference hole is near the electrical connector. The DEF pressure sensor has a nominal range of 0 to 0.8 MPa (0 to 8 bar, 0 to 116 psi). This pressure range is above the maximum intended operating pressure of 0.5 MPa. The sensor voltage saturates at slightly above 0.5 and slightly below 4.5 volts.



**DEF Pressure Sensor**

DEF pressure is often a vacuum when the system purges after running. Vacuums cannot be measured by the DEF pressure gauge sensor as voltages will not be lower than 0.5 Volts.

<b>DEF Pressure Sensor Transfer Function</b>		
<b>DEF Pump Pressure (PSI) = 29 * Voltage - 14.5</b>		
<b>Volts</b>	<b>Pressure, MPa (gauge)</b>	<b>Pressure, psi (gauge)</b>
5.00	0.8	116
4.50	0.8	116
3.50	0.6	87
2.50	0.4	58
1.00	0.1	14
0.500	0.0	0
0.250	0.0	0

## Reductant Pressure Sensor Signal Range Check

Reductant Pressure Sensor Open/Short Check Operation:	
DTCs	P204C - Reductant Pressure Sensor Circuit Low P204D - Reductant Pressure Sensor Circuit High
Monitor execution	Continuous
Monitor Sequence	none
Sensors OK	none
Monitoring Duration	0.4 seconds to register a malfunction

Typical Reductant Pressure Sensor Check Malfunction Thresholds:
Pressure sensor voltage < 0.20 volts or Pressure sensor voltage > 4.8 volts

A reductant Pressure Sensor that is substantially in error results in a DEF system fault (over or under injection). If actual DEF pressure exceeds measured pressure, more DEF than that which would be expected is injected and vice versa. This error would show up in the long term adaption trim (DEF LTA).

## Reductant Pressure Plausibility Check before Start-up

If the hydraulic circuit of the DEF system (pump, pressure line, & injector) is completely empty, i.e. purge cycle was successfully completed during previous drive cycle, the DEF pressure is expected to read 0 kPa. Based on sensor tolerances the deviation from zero is limited to 30 kPa.

Reductant Pressure Plausibility Check Operation:	
DTCs	P204B (SRC error for Reductant Pressure Sensor)
Monitor execution	Continuous, prior to pressure build-up
Monitor Sequence	P204B is inhibited by active P204C or P204D codes
Sensors/Actuators OK	none
Monitoring Duration	0.6 seconds to register a malfunction

Typical Reductant Pressure Plausibility Check Entry Conditions:		
Entry Condition	Minimum	Maximum
DEF pump and line not primed		0
DEF system not pressurized		
DEF tank and pump not frozen	True	

Typical Reductant Pressure Plausibility Check Malfunction Thresholds:
P204B: > 50 kPa for 0.6 sec



## DEF Pressure Build-up Check at Start-up

After the fill cycle is completed, the injector is closed and the system pressure is expected to rise.

Reductant Pressure Functional Check:	
DTCs	P20E8 – Reductant Pressure too Low
Monitor execution	Once during pressure build-up
Monitor Sequence	P20E8 is inhibited by active P204B, P204C or P204D codes
Sensors/Actuators OK	Reductant pressure sensor, Reductant pump motor, injector
Monitoring Duration	1 event (3 times 15 seconds)

Typical Reductant Pressure Plausibility Check Entry Conditions:		
Entry Condition	Minimum	Maximum
DEF pump and line not primed		0
DEF system not pressurized		
DEF tank not frozen	True	

Typical Reductant Pressure Plausibility Check Malfunction Thresholds:
P204B: pressure does not exceed 350 kPa after 45 sec with spinning pump

## DEF System Pressure Control

DEF pressure is maintained via feedback knowledge of sensed pressure. Pressure control is closed loop based on the voltage of the DEF pressure sensor. If a pressure increase is desired, the urea pump motor speed is increased by increasing the PWM output. Pressure decreases are analogous; as the system has a backflow throttle, pressure will decrease to 0 unless the pump motor in run continuously. Once the set point pressure (500 kPa) is reached the following diagnostics are enabled.

Reductant Pressure Control (Normal) Functional Check Operation:	
DTCs	P20E8 - Reductant Pressure Too Low P20E9 - Reductant Pressure Too High
Monitor execution	Continuous
Monitor Sequence	P20E8 & P20E9 are inhibited by active P204b, P204C or P204D codes
Sensors/Actuators OK	reductant pump pressure sensor, reductant pump motor, reductant injector
Monitoring Duration	> 10 sec (resp. > 60 sec, see below)

Typical Reductant Pressure Control (Normal) Functional Check Entry Conditions:		
Entry Condition	Minimum	Maximum
DEF system pressure in closed loop control previously	True	

Typical Reductant Pressure Control (Normal) Functional Check Malfunction Thresholds:
P20E8: < 400 kPa for 60 sec respectively < 300 kPa for 10 sec
P20E9: > 650 kPa for 10 sec respectively > 790 kPa for 1 sec

Reductant Metering Unit Functional Check Operation:	
DTCs	P20FE - Reductant Metering Unit Performance P20FF - Reductant Control Module Performance
Monitor execution	Continuous
Monitor Sequence	P007C, P007D – P20FE
Sensors/Actuators OK	CACT1 (P007C, P007D)
Monitoring Duration	P20FE - 5 sec, P20FF - continuously

Typical Reductant Metering Unit Functional Check Entry Conditions:		
Entry Condition	Minimum	Maximum
P20FE:		
Engine Off time	6 hrs	
CAC Downstream Temperature	-20 deg C	80 deg C

**Typical Reductant Metering Unit Functional Check Malfunction Thresholds:**

P20FE: If difference between reductant coil temperature and CAC temperature > 20 deg C, code is set.

P20FF: Non-volatile memory corruption detected

**Reductant Purge Control Valve Functional Check Operation:**

DTCs	P20A0 - Reductant Purge Control Valve "A" Circuit /Open P20A2 - Reductant Purge Control Valve "A" Circuit Low P20A3 - Reductant Purge Control Valve "A" Circuit High
Monitor execution	Continuous
Monitor Sequence	none
Sensors/Actuators OK	
Monitoring Duration	continuously

**Typical Reductant Purge Control Valve Functional Check Malfunction Thresholds:**

P20A0: voltage > 4.9 v

P20A2: voltage < 0.1 v

P20A3 voltage > 4.9 v

## Reductant Tank Level Sensor

The task of the discrete level sensor is to measure the tank level at 3 different heights. The determination of a reductant level is limited to liquid reductant. Frozen reductant cannot be detected. The measured level will be used to update the calculation of remaining quantity in the reductant tank.

The level sensor consists of four high-grade stainless steel pins. The length of each pin defines the tank level (height) which is to be checked. Only three pins can be used for level evaluation. The fourth pin is used as ground pin. Due to the electrical conductivity of Urea the level sensor will determine whether the tank level is above or below the respective level sensor position. This information will be directly evaluated by the ECU.

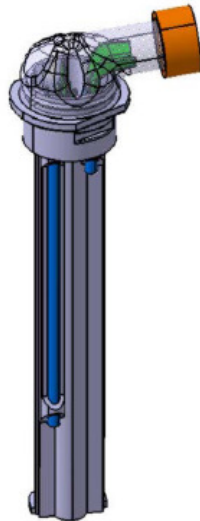

**Reductant Tank Level Sensor:**

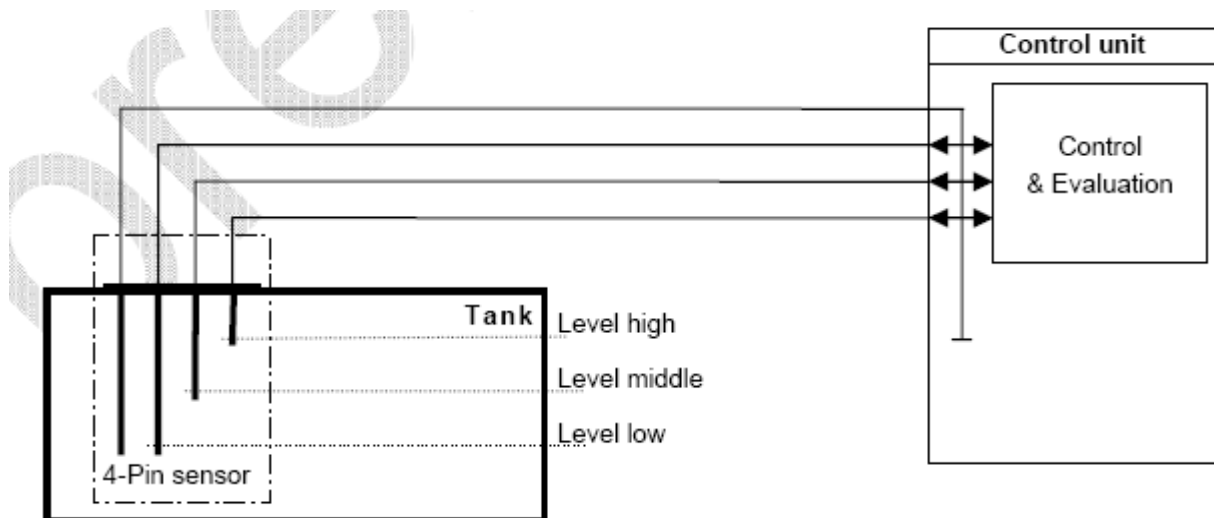

**Reductant Tank Level Sensor Circuit Tree**

## Reductant Tank Level Sensor Circuit Checks

Reductant Tank Level Sensor Open/Short Check Operation:	
DTCs	P203D - Reductant Level Sensor "A" Circuit High (SRC max – pin 1 & SCB) P21AB - Reductant Level Sensor "B" Circuit High (SRC max – pin 2) P21B0 - Reductant Level Sensor "C" Circuit High (SRC max – pin 3) P203A - Reductant Level Sensor Circuit (OL) P203C - Reductant Level Sensor Circuit Low (SCG)
Monitor execution	Continuous, every 4 seconds (3x 1 sec to read from each individual pin, 1 sec for diagnosis)
Monitor Sequence	None
Sensors OK	None
Monitoring Duration	0.5 seconds to register a malfunction within diagnostic mode

Typical Tank Level Sensor Open/Short Check Malfunction Thresholds:	
P203D, P21AB & P21B0: voltage > 3.24 Volts (Signal range check max. for pin 1, 2 & 3)	
P203D: no calibration thresholds available, SCB fault information is sent directly from power stage	
P203C: no calibration thresholds available, SCG fault information is sent directly from power stage	
P203A: no calibration thresholds available, OL fault information is sent directly from power stage	

The Reductant Tank Level Sensor and the Reductant Tank Temperature Sensor share the same ground wire. Therefore an open load or short circuit to battery on the ground wire (reference pin) will set codes for both sensors.

## Reductant Tank Level Sensor Plausibility Check

If a certain level pin is covered by liquid all pins below this level should be covered as well and send the same information. If this is not the case, an error flag will be set.

Reductant Tank Level Sensor Plausibility Check Operation:	
DTCs	P203B – Reductant Level Sensor Circuit Range/Performance
Monitor execution	Continuous
Monitor Sequence	none
Sensors/Actuators OK	Reductant Level sensor signal range checks
Monitoring Duration	60 seconds to register a malfunction

Typical Reductant Tank Level Sensor Plausibility Check Malfunction Thresholds:
no calibration thresholds available

## Reductant Tank Temperature Sensor

The Reductant Tank Temperature sensor is mounted internal to the Reductant Tank Level Sensor. It is used to control the activation of the Reductant Tank Heater as well as an enabler to the Level Sensor (which cannot read level when the reductant is frozen).

Transfer Function	
Temperature Deg C	Resistance (Ohms)
-40	336
-30	177
-20	97
-10	55
0	32
10	20
20	12
30	8
40	5.3
50	3.6
60	2.5
70	1.8
80	1.2

<b>Reductant Tank Temperature Circuit Range Check</b>	
DTCs	P205C Reductant Tank Temperature Sensor Circuit Low P205D Reductant Tank Temperature Sensor Circuit High
Monitor execution	continuous
Monitor Sequence	none
Sensors OK	not applicable
Monitoring Duration	0.4 seconds to register a malfunction

<b>Typical Intake Reductant Tank Temperature Circuit Range Check Malfunction Thresholds</b>
P205C: voltage < 0.097 Volts P205D: voltage > 3.201 Volts

### **Reductant Tank Temperature Plausibility Check**

On every cold start of the vehicle (min. soak time > 6 hours) the value of the tank temperature sensor is expected to be close to the environmental temperature.

<b>Reductant Tank Temperature Plausibility Check</b>	
DTCs	P2043 Reductant Temperature Sensor Circuit Range/Performance
Monitor execution	At cold start conditions / extended soak time
Monitor Sequence	P2043 is inhibited by active P205C or P205D codes
Sensors OK	Ambient temp sensor, exhaust gas temp. sensor upstream SCR catalyst, engine coolant temperature sensor (downstream)
Monitoring Duration	counts intermittent events per trip

<b>Typical Reductant Tank Temperature Plausibility Check Entry Conditions:</b>		
Entry Condition	Minimum	Maximum
Engine off timer	6 hours	
Reductant Tank Fluid level	10 %	100 %
Max (ambient temp, SCR catalyst temp., engine coolant temp.) - Min (ambient temp., SCR catalyst temp., engine coolant temp.)		10 deg C

<b>Typical Reductant Tank Temperature Plausibility Check Malfunction Thresholds</b>
Reductant tank temperature – ambient temperature > 20 deg C or < -20 deg C

## Exhaust Gas Temperature Sensor Rationality Test

Each EGT Sensor is checked continuously for proper circuit continuity and out of range high values. In addition, a rationality test is performed once every drive cycle, after a soak of 6 hours or greater. The rationality test consists of two components, the first being a comparison against modeled values, and the second being a key-on 4-way temperature sensor comparison. At key-on, a temperature sample is taken of each of the following sensors: Exhaust Gas Temperature (EGT11), Exhaust Gas Temperature (EGT12), Exhaust Gas Temperature (EGT13), and Exhaust Gas Temperature (EGT14). Once the engine starts and a cold start has been confirmed, the model comparison tests begin. The model comparison tests ensure that each sensor correlates with an expected modeled value, and a fault is set if the difference is significant (greater than upper threshold or less than lower threshold) and persistent. In the second rationality test, the temperature samples from 4 EGTs at key-on are compared against each other, and the temperature differences are compared against a threshold. One sensor must fail key-on plausibility with three other sensors to set a fault. If two or more sensors fail plausibility with the remaining sensors,, then appropriate faults pointing to the faulty EGTs are set. The first (model versus sensor) rationality tests rely on entry conditions that include engine on time, minimum modeled temperature, minimum engine coolant temperature, and minimum engine torque. Once the entry conditions have been met, the model comparisons continue for several minutes to ensure a robust detection. The modeled value for EGT11 is based on Modeled Turbo Temperatures. The modeled value for EGT12 is based on EGT11. The modeled value for EGT13 is based on EGT12. The modeled value for EGT14 is based on EGT13. In addition, both plausibility tests depend on minimum engine soak time of 6 hours or more.

### Exhaust Gas Temperature (EGT) Sensor Circuit Check:

DTCs	P0545 – Exhaust Gas Temperature Circuit Low (Sensor 1) P0546 – Exhaust Gas Temperature Sensor Circuit High (Sensor 1) P2478 – Exhaust Gas Temperature Out Of Range (Sensor 1) P2032 – Exhaust Gas Temperature Circuit Low (Sensor 2) P2033 – Exhaust Gas Temperature Sensor Circuit High (Sensor 2) P2479 – Exhaust Gas Temperature Out Of Range (Sensor 2) P242C – Exhaust Gas Temperature Circuit Low (Sensor 3) P242D – Exhaust Gas Temperature Sensor Circuit High (Sensor 3) P247A – Exhaust Gas Temperature Out Of Range (Sensor 3) P2470 – Exhaust Gas Temperature Circuit Low (Sensor 4) P2471 – Exhaust Gas Temperature Sensor Circuit High (Sensor 4) P247B – Exhaust Gas Temperature Out Of Range (Sensor 4)
Monitor Execution	Continuous
Monitor Sequence	None
Sensors OK	Not applicable
Typical Monitoring Duration	2 sec.

### Typical Exhaust Gas Temperature Sensor Circuit Check Entry Conditions:

Entry Condition	Minimum	Maximum
Battery Voltage	9 V	16.25 V
Key On		



**Typical Exhaust Gas Temperature Sensor Circuit Check Malfunction Thresholds:**

Voltage < 0.10 volts or voltage > 4.90 volts

Out Of Range test is based on Engineering Units and is high-side only. The Out Of Range Threshold is typically set to 1150 deg C. Transfer function of the sensors does not allow for unique circuit range and engineering range thresholds on the low-side.

The Exhaust Gas Temperature Sensor is a PTC Thermistor that provides an analog output voltage proportional to the exhaust gas temperature. This EGT sensor is capable of being used anywhere in the exhaust gas stream. Some possible applications are listed below:

- EGT Exhaust Gas Temp
- EGR\_CIT EGR Cooler Inlet Exhaust Gas Temp
- EGR\_COT EGR Cooler Outlet Exhaust Gas Temp
- DPF\_IN Diesel Particulate Filter Inlet Exhaust Gas Temp
- DPF\_OUT Diesel Particulate Filter Outlet Exhaust Gas Temp
- SCR\_IN SCR Inlet Exhaust Gas Temp
- SCR\_OUT SCR Outlet Exhaust Gas Temp

**EGT Sensor Transfer Function**

$$V_{out} = (V_{ref} * R_{sensor}) / (1K + R_{sensor})$$

Response Time: 1 time constant = 15 sec for 300 deg C step @ 10m/sec gas flow

Volts	A/D Counts in PCM	Ohms	Temperature, deg C
0.10		short circuit	n/a
0.71		171	-40
0.82		202	0
1.06		277	100
1.27		350	200
1.45		421	300
1.61		490	400
1.75		556	500
1.88		619	600
1.99		691	700
2.09		740	800
2.14		768	850
2.34			1100
2.66		open circuit	n/a

### Exhaust Gas Temperature Rationality Check

DTCs02.0	<p>Sensor vs. Model Plausibility</p> <p>P0544 – Exhaust Gas Temperature Sensor Circuit (Sensor 1)</p> <p>P2031 – Exhaust Gas Temperature Sensor Circuit (Sensor 2)</p> <p>P242A – Exhaust Gas Temperature Sensor Circuit (Sensor 3)</p> <p>P246E – Exhaust Gas Temperature Sensor Circuit (Sensor 4)</p> <p>Sensor to Sensor Plausibility</p> <p>P2080 - Exhaust Gas Temperature Sensor Circuit Range/Performance (Bank 1, Sensor 1)</p> <p>P2084 - Exhaust Gas Temperature Sensor Circuit Range/Performance (Bank 1, Sensor 2)</p> <p>P242B - Exhaust Gas Temperature Sensor Circuit Range/Performance (Bank 1, Sensor 3)</p> <p>P246F - Exhaust Gas Temperature Sensor Circuit Range/Performance (Bank 1, Sensor 4)</p>
Monitor Execution	Once per driving cycle.
Monitor Sequence	Correlation Test completes after the Model Comparison Tests once the cold start is detected.
Sensors OK	
Typical Monitoring Duration	Model Comparison Test Monitor Duration is 200 to 400 seconds.

### Typical Exhaust Gas Temperature Rationality Check Entry Conditions:

Entry Condition	Minimum	Maximum
Engine Off Time	6 hrs	N/A
Coolant Temp	68 deg C	N/A
Engine Run Time	120 seconds	
Modeled Sensor Temp	120 deg C for EGT11 100 deg C for EGT12 95 deg C for EGT13 90 deg C for EGT14	
Engine Torque	100 Nm	

### Typical Exhaust Gas Temperature Rationality Check Thresholds:

Each EGT Rationality is confirmed against 3 other sensors (absolute temperature difference thresholds):	
Key-On Comparison Threshold	50 deg C
Modeled Comparison Threshold	75 and -180 deg C for EGT11, $\pm 80$ deg C for EGT12, $\pm 60$ deg C for EGT13, $\pm 60$ deg C for EGT14
Modeled Comparison Duration	Comparison Test will run for 200 to 400 seconds. Fault must persist for 20 seconds for robust detection.

**Diesel Particulate Filter Over Temperature Check:**

DTCs	P200C– Diesel Particulate Filter Over Temperature (Bank1) P200E – Catalyst System Over Temperature (Bank 1)
Monitor Execution	Continuous
Monitor Sequence	None
Sensors OK	Not applicable
Typical Monitoring Duration	3 sec.
Thresholds	P200C – Pre DPF > 830C or Post DPF > 950C or Post DPF Temp Sensor Circuit failure  P200E - The conditions for P200C have been met for 3 seconds and vehicle speed is less than 1 km/hr

**Diesel Particulate Filter Pressure Sensor Rationality Test**

The DPFP Sensor is checked continuously for proper circuit continuity, stuck sensor and pressure sensor plausibility.

**Diesel Particulate Filter Pressure (DPFP) Sensor Circuit Check:**

DTCs	P2454 – DPFP Sensor Circuit Low P2455 – DPFP Sensor Circuit High
Monitor Execution	Continuous
Monitor Sequence	None
Sensors OK	Not applicable
Typical Monitoring Duration	2 sec.

**Typical Diesel Particulate Filter Pressure Sensor Circuit Check Entry Conditions:**

Entry Condition	Minimum	Maximum
Battery Voltage	9 V	16.25 V
Key On		

**Typical Diesel Particulate Filter Pressure Sensor Circuit Check Malfunction Thresholds:**

Voltage < 0.10 volts or voltage > 4.90 volts

<b>DPFP Sensor Transfer Function</b>		
DPFP volts = 0.082 * kPaG Delta Pressure) + 0.45		
Volts	A/D Counts in PCM	Delta Pressure, kPa Gauge
0.10	20	-4.3
0.45	92	0
1.27	260	10
2.09	428	20
2.91	595	30
3.73	763	40
4.55	931	50
4.90	1003	54.3

### **Diesel Particulate Filter Pressure Offset Test**

The DPFP Sensor is checked during after-run conditions (period where the key is turned off, however the ECU is still powered), to verify that the sensor has not drifted from the ambient with no exhaust flow. This test is performed by comparing the sensed pressure to a threshold (due the gauge sensor, this value should be 0)

<b>Diesel Particulate Filter Pressure Sensor Offset Check</b>	
DTCs	P2452 – DPFP Sensor Circuit "A"
Monitor Execution	Afterrun
Monitor Sequence	None.
Sensors OK	DPFP Sensor
Typical Monitoring Duration	1 second.

### **Typical Diesel Particulate Filter Pressure Sensor Offset Check Thresholds:**

Exhaust Pressure Sensor value > 1 kPa

## Delta Pressure Sensor

The DPS is a dual port delta pressure sensor that provides an analog output voltage that is proportional to pressure drop and is typically used before and after a DPF (Diesel Particulate Filter) to monitor the differential pressure.

### Diesel Particulate Filter Delta Pressure (DPS) Sensor Circuit Check:

DTCs	P2460 – DPS Sensor Circuit Low P2461 – DPS Sensor Circuit High
Monitor Execution	Continuous
Monitor Sequence	None
Sensors OK	Not applicable
Typical Monitoring Duration	2 sec.

### Typical Diesel Particulate Filter Delta Pressure Sensor Circuit Check Entry Conditions:

Entry Condition	Minimum	Maximum
Battery Voltage	9 V	16.25 V
Key On		

### Typical Diesel Particulate Filter Delta Pressure Sensor Circuit Check Malfunction Thresholds:

Voltage < .10 volts or voltage > 4.90 volts

### Diesel Particulate Filter Pressure Sensor Rationality Check

DTCs	P246D – Particulate Filter Pressure Sensor “A”/”B” Correlation
Monitor Execution	Continuous.
Monitor Sequence	None.
Sensors OK	
Typical Monitoring Duration	2 seconds.

### Typical Diesel Particulate Filter Pressure Sensor Rationality Check Entry Conditions:

Entry Condition	Minimum	Maximum
Environmental Pressure	745 hPa	
Environmental Temperature	-40 Deg C	
Coolant Temperature	70 Deg C	
Pre DPF Temperature	125 Deg C	425 Deg C
Exhaust Flow	200 kg/hr	600 kg/hr

### Typical Diesel Particulate Filter Pressure Sensor Rationality Check Thresholds:

If the absolute difference between pressure indicated by the DPFP and DPS > 1.5 kPa, this DTC will set.

**DPS Sensor Transfer Function**

$$\text{DPFP volts} = 0.082 * \text{kPaG Delta Pressure} + 0.45$$

Volts	Delta Pressure, kPa Gauge
0.5	0.0
1.0	4.4
1.6	9.6
2.0	13.1
2.6	18.4
3.0	21.9
3.6	27.1
4.0	30.6
4.6	35.9
4.8	37.6

## Driver Input Devices

### Accelerator Pedal Diagnostics

#### Accelerator Pedal Diagnostic Circuit and Plausibility Checks:

DTCs	P2122 – Throttle/Pedal Position Sensor/Switch "D" Circuit Low P2123 – Throttle/Pedal Position Sensor/Switch "D" Circuit High P2127 – Throttle/Pedal Position Sensor/Switch "E" Circuit Low P2128 – Throttle/Pedal Position Sensor/Switch "E" Circuit High P2138 – Throttle/Pedal Position Sensor/Switch "D"/"E" Voltage Correlation
Monitor execution	Continuous
Monitor Sequence	None
Sensors OK	
Monitoring Duration	0.3 seconds

#### Typical Accelerator Pedal Diagnostic Thresholds:

P2122 – Observed voltage on first pedal track <0.25V  
P2123 – Observed voltage on first pedal track >4.75V  
P2127 – Observed voltage on second pedal track <0.25V  
P2128 – Observed voltage on second pedal track > 4.75V  
P2138 – The absolute value of the difference between ((voltage on pedal track 1)/2 – voltage on pedal track 2) exceeds a threshold dependent on pedal track 2 voltage (0.25V @ pedal track 2 voltage of 1.2V, 0.5V @ pedal track 2 voltage of 1.96V)

### Brake Switch Diagnostics

#### Brake Switch Plausibility Checks:

DTCs	P0504 – Brake Switch "A"/"B" Correlation P0572 – Brake Switch "A" Circuit Low P0573 – Brake Switch "A" Circuit High
Monitor execution	Continuous
Monitor Sequence	None
Sensors OK	
Monitoring Duration	Varies with driving conditions

#### Typical Brake Switch Diagnostic Thresholds:

P0504 – Brake switches disagree (pressed/not pressed) for 40 braking events  
P0572 – No brake switch activation seen for 40 inferred braking events  
P0573 – Brake switch activation seen for 40 inferred acceleration events

## Engine Outputs

### EGR Valve Actuator Signal Range Check

The diagnostics for the circuit range check on the pwm signal to the EGR valve are internal to the h-bridge PWM power-stage. Short-circuit to ground, and short-circuit to battery are detected on both the positive and negative control lines to the actuator.

EGR Valve Actuator Short Circuit (P0489/P0490) Check Operation:	
DTCs	P0489 – EGR "A" Control Circuit Low, P0490 – EGR "A" Control Circuit High P0403 – Exhaust Gas Recirculation "A" Control Circuit
Monitor execution	Continuous; when Power-stage ON
Monitor Sequence	None
Monitoring Duration	0.35 seconds to register a malfunction

### EGR Valve Offset Learn Limits

When the engine is shut down with ECT > 70 C (typical) an offset learn is performed on the EGR valve. If the learned values are outside the calibrated limits, a P0404 is set. Two offset learned values are generated due to lash in the EGR valve gearset and the EGR valve position being measured at the motor side of the gearset. The "Min" learn is the position where the motor is pressing the valve into the seat. The "Edge" learn is the position just before the valve starts to lift off the seat where the lash in the gearset has been taken up.

EGR Valve Offset Learn Limits :	
DTCs	P0404 – Exhaust gas recirculation (EGR) "A" control circuit range / performance
Monitor execution	At completion of offset learn
Monitor Sequence	None
Monitoring Duration	Immediate at completion of offset learn

EGR Valve Offset Learn Limits Entry Conditions:		
Entry Condition	Minimum	Maximum
EGR valve offset learning complete		

EGR Valve Offset Learn Limits Malfunction Thresholds:
"Edge" Offset Learn < 7.5 or "Edge" Offset Learn >32.5 or "Min" Offset Learn < 0 or "Min" Offset Learn >25



## EGR Valve Actuator Jammed Detection

The EGR valve has a component level diagnostic to make sure that the valve is not stuck or sticking in a manner such that it cannot reach the desired position. The monitor runs if a jammed valve is not already detected, position control is in closed-loop control, and adaptive learning is not active. A minimum engine speed is used as an entry condition.

If the position governor deviation is above a maximum calibrated threshold then counter starts to count up for the detection of a permanent positive control fault. If the counter reaches a calibrated threshold then a jammed valve malfunction is detected. Similarly, if the position governor deviation is below a minimum calibrated threshold then a second counter starts to count up for the detection of permanent negative control deviation fault. If the counter reaches a calibration threshold then a jammed valve is detected.

<b>EGR Valve Jammed Check Operation:</b>	
DTCs	P042E – Exhaust Gas Recirculation "A" Control Stuck Open
Monitor execution	Continuous
Monitor Sequence	None
Monitoring Duration	5 seconds to register a malfunction

<b>Typical Actuator Jammed Valve Entry Conditions:</b>		
Entry Condition	Minimum	Maximum
Governor Active (closed-loop position control)		
Adaptive Learning Not Active		
Jammed Valve Fault Not Present on Actuator		
RPM	700 rpm	

<b>Typical EGR Valve Jammed Check (P042E) Malfunction Thresholds:</b>
Position Error > 8.60 or Position Error < -8.60

## Throttle Valve Actuator Signal Range Check

The diagnostics for the circuit range check on the pwm signal to the throttle valve are internal to the h-bridge PWM power-stage. Short-circuit to ground, and short-circuit to battery are detected on both the positive and negative control lines to the actuator.

Throttle Valve Actuator Short Circuit (P02E2/P02E3) Check Operation:	
DTCs	P02E2- Diesel Intake Air Flow Control Circuit Low; P02E3- Diesel Intake Air Flow Control Circuit High  P02E0 – Diesel Intake Air Flow Control Circuit/Open
Monitor execution	Continuous; when power stage ON
Monitor Sequence	None
Monitoring Duration	0.2 seconds to register a malfunction.

## Throttle Valve Offset Learn Limits

When the engine is shut down with ECT > 70 C (typical) an offset learn is performed on the Throttle valve. If the learned value is outside the calibrated limits, a P0488 is set. The Throttle offset learn is for the open position of the throttle.

Throttle Valve Offset Learn Limits:	
DTCs	P0488 – Exhaust gas recirculation throttle control “A” control circuit range / performance
Monitor execution	At completion of offset learn
Monitor Sequence	None
Monitoring Duration	Immediate at completion of offset learn

Throttle Valve Offset Learn Limits Entry Conditions:		
Entry Condition	Minimum	Maximum
Throttle valve offset learning complete		

Throttle Valve Offset Learn Limits Malfunction Thresholds:
“Min” Offset Learn < -11 or “Min” Offset Learn >10

## Throttle Valve Actuator Jammed Detection

The throttle valve has a component level diagnostic to make sure that the valve is not stuck or sticking in a manner such that it cannot reach the desired position. The monitor runs if a jammed valve is not already detected, position control is in closed-loop control, and adaptive learning is not active.

If the position governor deviation is above a maximum calibrated threshold then counter starts to count up for the detection of a permanent positive control fault. . If the counter reaches a calibrated threshold then a jammed valve malfunction is detected. Similarly, if the position governor deviation is below a minimum calibrated threshold then a second counter starts to count up for the detection of permanent negative control deviation fault. If the counter reaches a calibration threshold then a jammed valve is detected.

A special case exists if the throttle is jammed in the closed position during crank. When the throttle is jammed in the closed position the engine is unable to start. The counter counts up more quickly to allow for the fault to be detected before the crank ends.

<b>Actuator Jammed Valve Check Operation:</b>	
DTCs	P02E1 – Diesel Intake Air Flow Control Performance,
Monitor execution	Continuous
Monitor Sequence	None
Monitoring Duration	5 seconds to register a fault during normal operation. 1 second to register a malfunction during crank.

<b>Typical Actuator Jammed Valve Entry Conditions:</b>
<b>Entry Condition</b>
Governor Active (closed-loop position control)
Adaptive Learning Not Active
Jammed Valve Fault Not Present on Actuator

<b>Typical Throttle Jammed Valve Check (P02E1) Malfunction Thresholds:</b>
Position Governor Deviation > 12.5% or <-12.5 %

## ECB Valve Actuator Signal Range Check

ECB Actuator Open-Load Check Operation:	
DTCs	P2425 - Exhaust Gas Recirculation Cooling Valve Control Circuit Open Load
Monitor execution	Continuous;
Monitor Sequence	None
Monitoring Duration	2 seconds to register a malfunction

ECB Actuator Short-Circuit (P2426/P2427) Check Operation:	
DTCs	P2426- Exhaust Gas Recirculation Cooling Valve Control Circuit Low, P2427- Exhaust Gas Recirculation Cooling Valve Control Circuit High
Monitor execution	Continuous;
Monitor Sequence	None
Monitoring Duration	2 seconds to register a malfunction.

## Urea System Pressure Control

Urea pressure is maintained via feedback knowledge of sensed pressure. A set point pressure is determined by engine operating conditions (500 kPa over exhaust backpressure). If a pressure increase is desired, the urea pump motor speed is increased by increasing the PWM output. Pressure decreases are analogous; as the system has a backflow throttle, pressure will decrease to 0 unless the pump motor in run continuously.

Urea Pump Pressure Control (Normal) Functional Check Operation:	
DTCs	P20E8 (Reductant Pressure Too Low) P20E9 (Reductant Pressure Too High)
Monitor execution	continuous
Monitor Sequence	P204C and P204D must complete before setting P20E8 or P20E9
Sensors/Actuators OK	Urea pump pressure sensor, Urea pump motor, Urea injector
Monitoring Duration	> 60 sec

Typical Urea Pump Pressure Control (Normal) Functional Check Entry Conditions:		
Entry Condition	Minimum	Maximum
Reductant system pressurized and ready to inject		

Typical Urea Pump Pressure Control (Normal) Functional Check Malfunction Thresholds:
P20E8: < 350 kPa P20E9: > 700 kPa

## Reductant Pump Motor

The Reductant Pump is driven by a brushless DC electric 12 volt motor. The pump is a positive displacement diaphragm design connected to the motor by a connecting rod and an eccentric on the motor shaft.

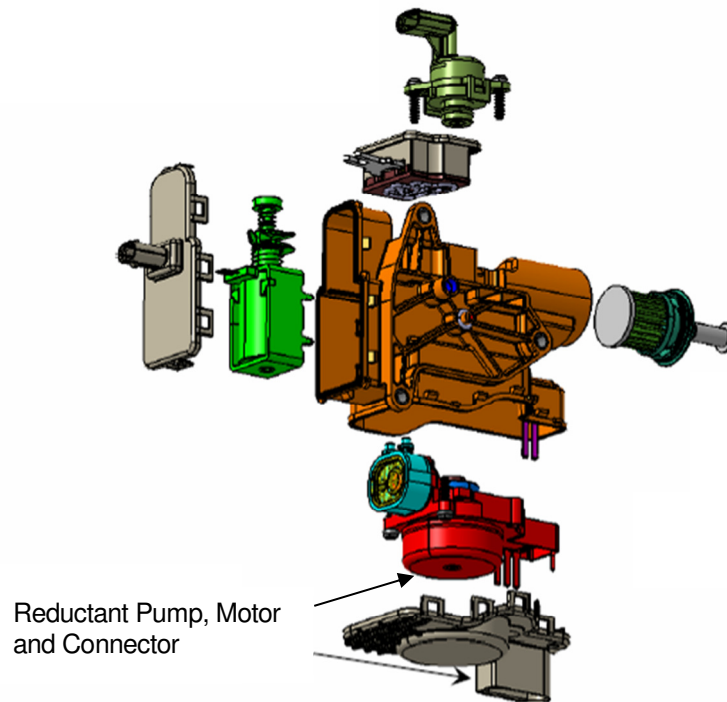

Reductant Pump Motor speed is controlled by a PWM driver in the engine ECU. Increasing the duty cycle of the PWM increases the Pump Motor speed. PWM duty cycles between 87 and 95 are reserved for diagnostics.

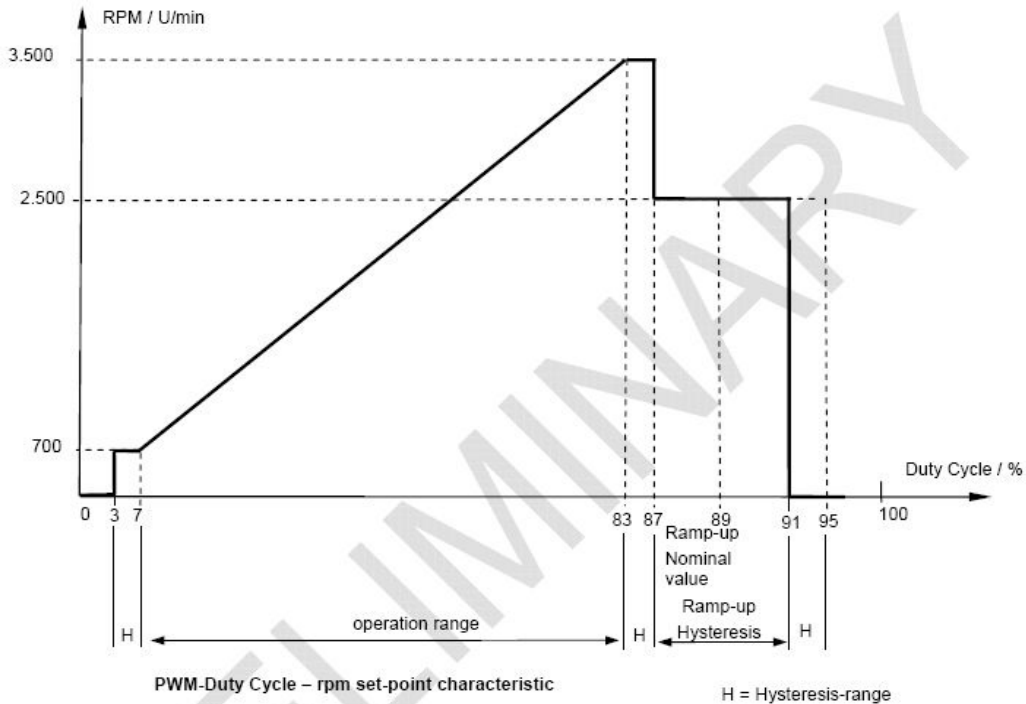

## Reductant Pump Motor Circuit Checks

Reductant Pump Motor Open/Short Check Operation:	
DTCs	P208A – Reductant Pump Control Circuit Open P208C – Reductant Pump Control Circuit Low P208D – Reductant Pump Control Circuit High
Monitor execution	Continuous – Open and Low with driver off / High with driver on
Monitor Sequence	none
Sensors OK	none
Monitoring Duration	Circuit Open / Low: 8 seconds to register a malfunction Circuit High: 2 seconds to register a malfunction

Typical Reductant Motor Check Malfunction Thresholds:
No calibration thresholds available, fault information is sent directly from power stage.
P208A - Reductant Pump Control Open Circuit > 5.80 volts
P208C - Reductant Pump Control Circuit Low < 3.50 volts
P208D - Reductant Pump Control Circuit High > 2.2 amps

## Reductant Pump Motor Functional Check

The functional check monitors the Pump Motor Speed Deviation. This test is run if the commanded pump speed is within normal operating range, i.e. duty cycle 6.5 to 80 %. In this test if the internal RPM measurement of the Reductant Pump Motor speed is not matching the commanded speed within a certain percentage, a fault is detected and the system is shut down for this key cycle.

Reductant Pump Motor Control (Normal) Functional Check Operation:	
DTCs	P208B – Reductant Pump Control Range/Performance
Monitor execution	continuous
Monitor Sequence	P208A , P208C, P208D must complete
Sensors/Actuators OK	Reductant pump pressure sensor, Reductant injector
Monitoring Duration	5 sec for fault detection

Typical Reductant Pump Motor Control (Normal) Functional Check Malfunction Thresholds:
P208B: > 300 RPM error

## Reductant Dosing Valve (Injector)

The reductant dosing valve is used to meter and atomize the reductant liquid before it is mixed with the exhaust gas. Normal operating frequency is between 3 Hz and .3 Hz. The cooling body contains heat sink fins to keep the injector and reductant below the boiling point. If the sensed temperature is nearing the maximum temperature threshold, reductant spray will be increased in quantity to actively cool the valve.

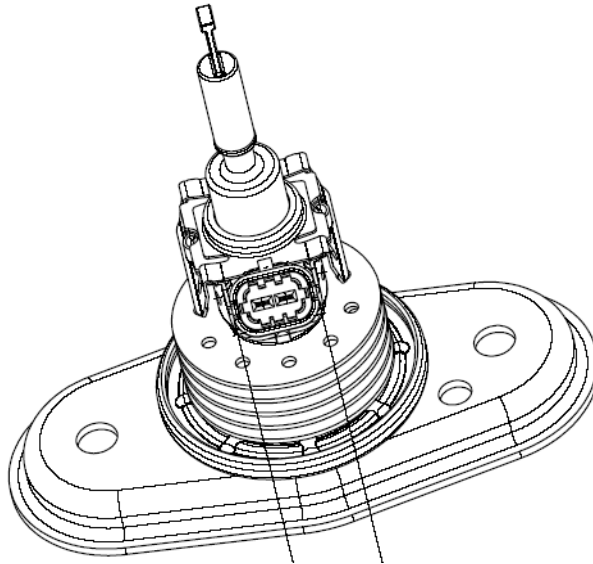

## Reductant Dosing Valve Circuit Checks

Reductant Dosing Valve Circuit Check Operation:	
DTCs	P2047 – Reductant Injection Valve Circuit / Open (Bank 1 Unit 1) P2048 – Reductant Injection Valve Circuit Low (Bank 1 Unit 1) P2049 – Reductant Injection Valve Circuit High (Bank 1 Unit 1)
Monitor execution	Continuous
Monitor Sequence	none
Sensors OK	none
Monitoring Duration	2 seconds to register a malfunction

Typical Reductant Dosing Valve Circuit Check Malfunction Thresholds:
No calibration thresholds available, fault information is sent directly from power stage
P2047 – Reductant Injection Valve Circuit / Open (Bank 1 Unit 1) - >5.80 volts
P2048 – Reductant Injection Valve Circuit Low (Bank 1 Unit 1) - < 3.2 volts HS, < 3.5 volts LS
P2049 – Reductant Injection Valve Circuit High (Bank 1 Unit 1) - > .4 volts HS, >2.2 amps LS

## Plausibility Check for Pump Motor Duty Cycle (Clogging)

The Pump Motor Duty Cycle is monitored depending on Urea dosing request.

Plausibility Check for Reductant Flow:	
DTCs	P218F - Reductant System Performance
Monitor execution	continuous
Monitor Sequence	P208A , P208C, P208D must complete
Sensors/Actuators OK	Urea pump pressure sensor, Urea injector
Monitoring Duration	2 sec for fault detection – 3 events per drive cycle

Typical Plausibility Check for Pump Motor Duty Cycle Entry Conditions:		
Entry Condition	Minimum	Maximum
CoSCR_stSub	Metering control	Metering control

Typical Plausibility Check for Pump Motor Duty Cycle Malfunction Thresholds:
P218F (Reductant no flow): - no dosing: pump duty cycle < 6.75 % - dosing: pump duty cycle increase < 5 % (dosing rate > 200 mg/sec)



## Reductant Dosing Valve Functional Check

The functional check monitors the movement of the injector needle. When the injector needle reaches its upper position (injector open, begin of injection period) a discontinuity in the slope of the dosing valve current occurs.

This functional check monitors the presence of this discontinuity. If it does not occur the injector is either stuck open or stuck closed. In both case the system cannot be operated and will be shut down.

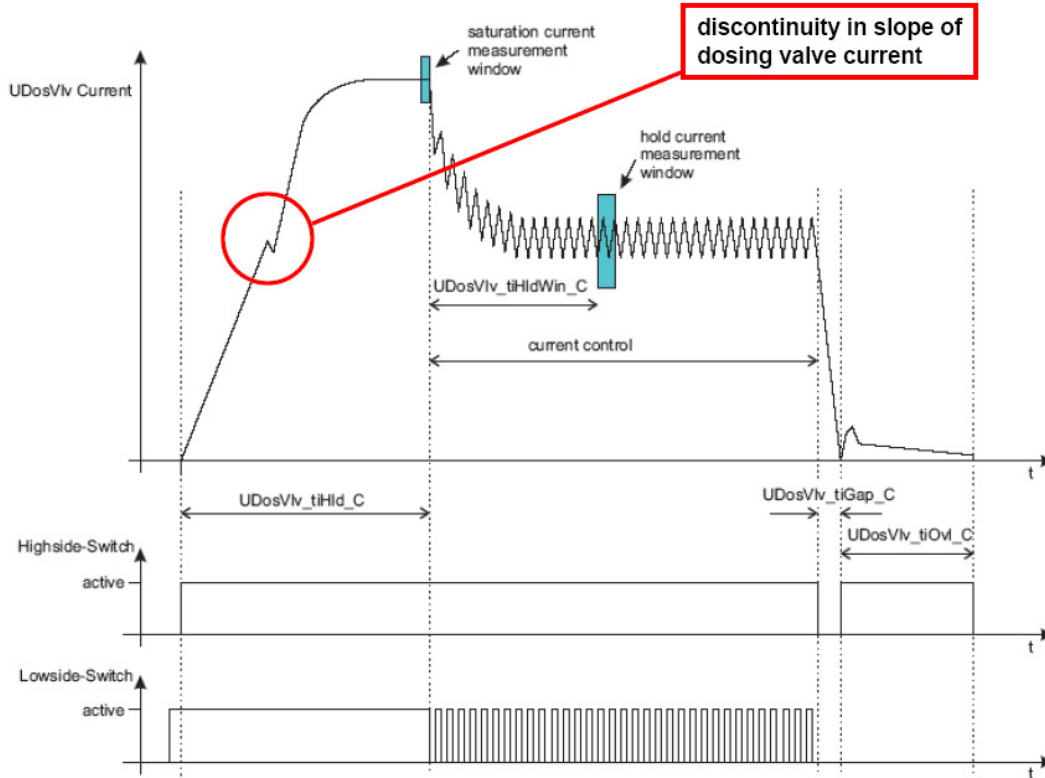

### Reductant Injection Functional Check Operation:

DTCs	P208E - Reductant Injection Valve Stuck Closed (Bank 1 Unit 1)
Monitor execution	Once per injection stroke
Monitor Sequence	P208E is inhibited by active P2047, P2048 or P2049
Sensors/Actuators OK	Reductant pump motor, Reductant pressure sensor
Monitoring Duration	50 injection strokes for fault detection

### Typical Reductant Injection Functional Check Malfunction Thresholds:

No calibration thresholds available, fault information is sent directly from power stage

## Reverting Valve

In order to reverse the Reductant flow direction (for line purge) a 4-2-way valve (reverting valve) needs to be switched. The valve is switched by a solenoid.

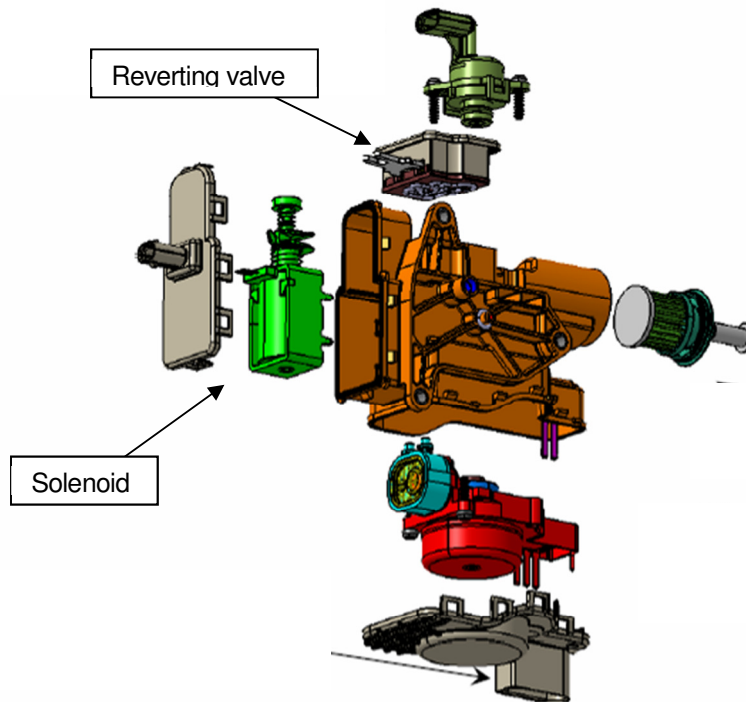

## Reverting Valve Circuit Checks

Reverting Valve Circuit Check Operation:	
DTCs	P20A0 – Reductant Purge Control Valve Circuit / Open P20A3 – Reductant Purge Control Valve Circuit High P20A2 – Reductant Purge Control Valve Circuit Low
Monitor execution	Continuous – Open and Low with driver off / High with driver on
Monitor Sequence	none
Sensors OK	none
Monitoring Duration	2 seconds to register a malfunction

Typical Reverting Valve Circuit Check Malfunction Thresholds:	
No calibration thresholds available, fault information is sent directly from power stage	

## Reverting Valve Functional Check

The functional check monitors the pressure for no increase when the purge cycle is started. To run this test the vehicle ignition is turned off, then a calibrated delay time (7 sec) is used. Once the delay expires, the pump and reverting valve are actuated. For a successful test result, the pressure must not increase by another threshold (50.0 kPa) within the given purge time – Typically purge is 5 seconds.

If the test is not successfully passed the purge cycle will be terminated immediately because of the risk of uncontrolled injection of reductant into the exhaust pipe.

<b>Reverting Valve Functional Check Operation:</b>	
DTCs	P20A1 - Reductant Purge Control Valve Performance
Monitor execution	Once per drive cycle
Monitor Sequence	P20A1 is inhibited by active P20A0 , P20A3 or P20A2
Sensors/Actuators OK	reductant pump pressure sensor, reductant injector, reductant pump motor
Monitoring Duration	7 secs after key off with no monitoring. Then 5 seconds of monitoring with pump on reverting valve actuated (purge)

<b>Typical Reverting Valve Functional Check Malfunction Thresholds:</b>
P20A1- Max. pressure increase >50.0 kPa error during purge (reverse flow expected) - 1 event > 50.0 kPa during the monitoring window.

## Urea Heaters

Aqueous urea water solution (Diesel Exhaust Fluid) freezes at  $-11^{\circ}\text{C}$  (12 deg. F). In order to keep the fluid liquid at low ambient temperatures, the system includes 3 heaters:

- tank heater (PTC heater element – self regulating)
- pump heater (PTC heater element – self regulating)
- pressure line heater (Resistance heater)

The heater power stages are located in the glow plug control module (GPCM). The tank heater is connected to heater power stage #1. The pressure line & pump heater are connected in parallel to heater power stage #2.

All SCR-heater related circuit checks are performed inside the GCU. The information is sent via CAN to the engine control module (ECM).

Additionally the GCU sends the supply voltage and the actual heater current for each circuit to the ECM.

Based on this information the heater plausibility checks are performed on the ECM.

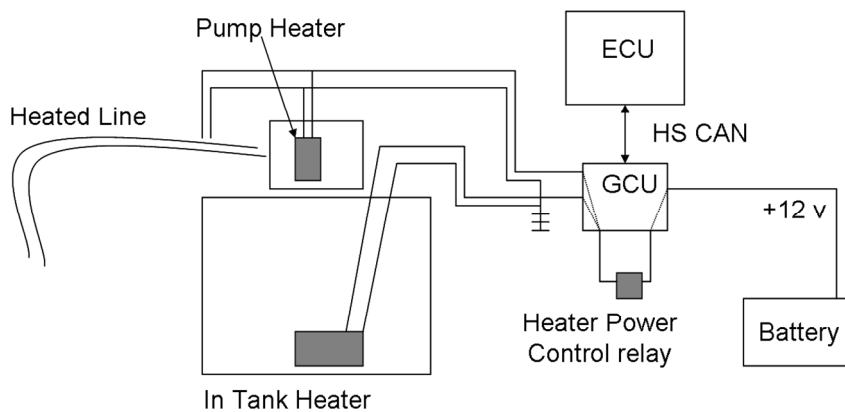

## Reductant Heater Plausibility Checks

Based on the information of heater voltage and heater current, the actual conductance at peak power is calculated for each heater circuit. This value is checked against the nominal value including tolerances.

Typical characteristic of PTC heater conductance:

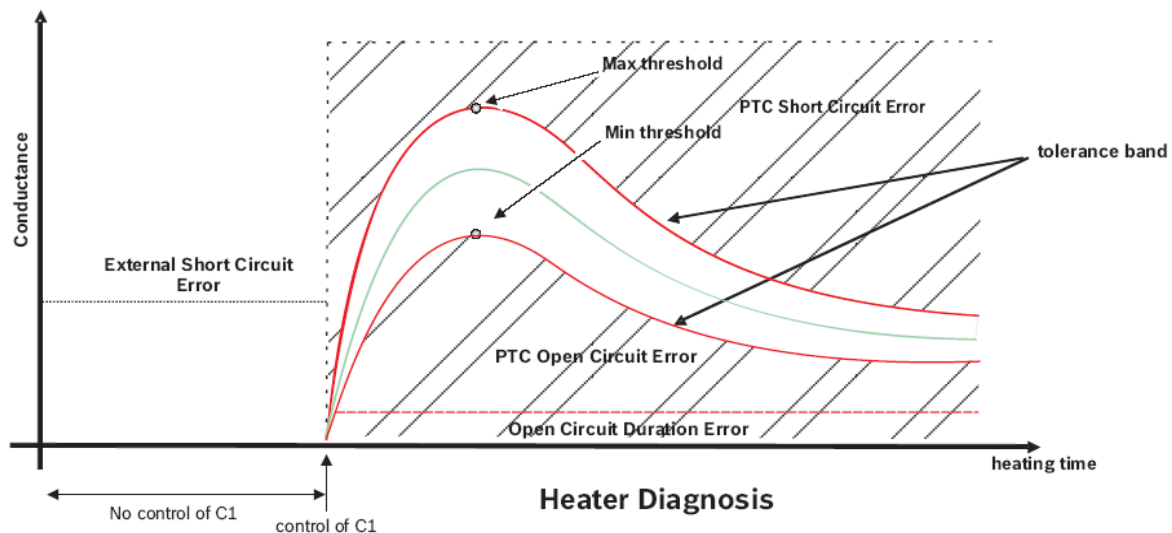

<b>Reductant Heater Plausibility Check Operation:</b>	
DTCs	P20BA – Reductant Heater "A" Control Performance P20BE – Reductant Heater "B" Control Performance P263D – Reductant Heater Driver Performance
Monitor execution	Once per drive cycle (at peak heater power)
Monitor Sequence	P20B9, P20BB, P20BC must complete for P20BA P20BD, P20BF, P20C0 must complete for P20BE
Sensors/Actuators OK	none
Monitoring Duration	1 event for fault detection

<b>Typical Reductant Heater Plausibility Check Malfunction Thresholds:</b>	
P20BA:	> nominal conductance of heater circuit #1 + max. tolerance or < nominal conductance of heater circuit #1 – max. tolerance
P20BE:	> nominal conductance of heater circuit #2 + max. tolerance or < nominal conductance of heater circuit #2 – max. tolerance
P263D:	Driver circuit temperatures > 125C

#### **Additional plausibility check for heater circuit #2:**

Pump heater & pressure line heater are connected in parallel to heater power stage #2. In order to be able to detect a failure of just one of both heaters, the conductance of heater circuit #2 is continuously checked against a minimum threshold. E.g. if the pressure line heater gets disconnected after peak conductance occurred, neither the plausibility check nor the circuit checks inside the GCU can detect this error. Therefore this continuous check becomes necessary.

<b>Reductant Heater Plausibility Check Operation (Heater Circuit #2):</b>	
DTCs	P20BE – Reductant Heater "B" Control Performance
Monitor execution	Continuously, if heater "B" is activated
Monitor Sequence	P20BD, P20BF, P20C0 must complete for P20BE
Sensors/Actuators OK	Pressure line heater
Monitoring Duration	2200 ms for fault detection

<b>Typical Reductant Heater Plausibility Check Malfunction Thresholds (Heater Circuit #2):</b>	
P20BE:	conductance of heater circuit #2 < 0.3 $\Omega^{-1}$

**Reductant tank heater performance check (heater circuit #1):**

The tank heater is located in close proximity to the tank temperature sensor. Therefore the tank temperature sensor can be used to monitor the tank heater performance only when the heater is commanded on.

When the tank heater is activated, the tank temperature is expected to rise. If this is not the case a fault will be set. If the vehicle is operated for several consecutive short drive cycles, the test may require more than one drive cycle to complete.

<b>Reductant Heater Performance Check Operation (Heater Circuit #1):</b>	
DTCs	P209F – Reductant Tank Heater Control Performance
Monitor execution	Once per heat cycle (after cold start)
Monitor Sequence	P20B9, P20BB, P20BC must complete for P209F
Sensors/Actuators OK	tank temperature sensor, tank heater
Monitoring Duration	2200 ms for fault detection

<b>Typical Reductant Heater Performance Check Malfunction Thresholds (Heater Circuit #1):</b>
P209F: temperature increase < 0.5°C

**Engine Control Unit (ECU) Monitor Operation:**

DTCs	P0600 - Serial Communication Link P0601 - Internal Control Module Memory Checksum Error P0603 - Internal Control Module Keep Alive Memory (KAM) Error P0606 - Control Module Processor P0607 - Control Module Performance P060A - Internal Control Module Monitoring Processor Performance P060B - Internal Control Module A/D Processing Performance P060D - Internal Control Module Accelerator Pedal Position Performance P0611 - Fuel Injector Control Module Performance P061A - Internal Control Module Torque Performance P061B - Internal Control Module Torque Calculation Performance P061C - Internal Control Module Engine RPM Performance P062B - Internal Control Module Fuel Injector Control Performance P062F - Internal Control Module EEPROM Error P06A6 - Sensor Reference Voltage "A" Circuit Range/Performance P06A7 - Sensor Reference Voltage "B" Circuit Range/Performance P06A8 - Sensor Reference Voltage "C" Circuit Range/Performance P167F - Non-OEM Calibration Detected P2507 - ECM / PCM Power Input Signal Low P2508 - ECM / PCM Power Input Signal High P2610 - ECM / PCM Engine Off Timer Performance
------	-------------------------------------------------------------------------------------------------------------------------------------------------------------------------------------------------------------------------------------------------------------------------------------------------------------------------------------------------------------------------------------------------------------------------------------------------------------------------------------------------------------------------------------------------------------------------------------------------------------------------------------------------------------------------------------------------------------------------------------------------------------------------------------------------------------------------------------------------------------------------------------------------------------------------------------------------------------------------------------------------------------------------------------------------------------------------------------------------------------------------------------------------------------------------------------------------------

Monitor Execution	P0600, P0603, P0606, P060A, P060B, P060D, P0611, P061A, P061B, P061C, P062B, P062F, P06A6, P06A7, P06A8, P167F, P2507, P2508, P2610, – Continuous P0601 – Postdrive P0607 – 20 s
Monitor Sequence	None
Sensors OK	None
Typical Monitoring Duration	P0600, P0601, P0603, P0606, P060A, P060B, P060D, P061B, P061C, P062B, P062F, P06A6, P06A7, P06A8, P167F, P2507, P2508, P0611 – 5 sec P061A – 0.1 sec , P2610 – 8 sec

**Typical Engine Control Unit (ECU) Monitor Entry Conditions:**

Entry condition	Minimum	Maximum
P0600, P0603, P0606, P0607, P060A, P060B, P060D, P061A, P061B, P061C, P062B, P062F, P06A6, P06A7, P06A8, P167F, P2507, P2508, P2610: ECU energized (key-on, engine running, or post-drive before ECU shutdown)		
P0601: Post-drive		
P0611: Engine running or cranking		



## Typical Engine Control Unit (ECU) Monitor Malfunction Thresholds:

P0600 – A data transfer between chips in the ECU either is not possible or has invalid check bytes

OR Communication is interrupted between the CPU and the monitoring module

P0601 – An error is detected in the post-drive ROM test

P0603 – Voltage on the separate power supply for the ECU engine off timer chip (power supply used when the main ECU is shut down) is  $< 0.25\text{V}$  (normal operation: battery voltage  $\sim 12\text{V}$ )

P0606 – A communications error exists between the powerstage controller chip and the CPU OR an internal chip error has been detected within the voltage generation/monitoring system for the ECU OR voltage at 5V supply in ECU is  $< 4.7\text{V}$  or  $> 5.3\text{V}$

P0607 – Five errors with internal ECU communication with the monitoring module chip are detected

P060A – An irreversible error occurs with an operating system function call OR An irreversible error occurs in the test of the monitoring module

P060B – Failure on power-up calibration done for the A/D conversion module and A/D conversion time performed on ECU start OR  $> 249\text{ mV}$  reading in the cycle following grounding of a specific voltage OR Cyclical conversion of a predetermined voltage results in  $< 4727\text{ mV}$  or  $> 4830\text{ mV}$  reading.

P060D – If either pedal voltage 1 or pedal voltage 2  $< 742\text{ mV}$  and  $(\text{pedal voltage } 1) - 2 * (\text{pedal voltage } 2) > 547\text{ mV}$  OR If pedal voltage 1 and pedal voltage 2  $\geq 742\text{ mV}$  and  $(\text{pedal voltage } 1) - 2 * (\text{pedal voltage } 2) > 1055\text{ mV}$

P0611 – If the raw voltage detected by an internal ECU voltage measurement for fuel system Nominal Voltage Calibration falls below  $0\text{ mV}$  or above  $3300\text{ mV}$  for the monitoring duration

P061A – Commanded inner torque  $>$  permissible inner torque at current engine operating condition

P061B – The energizing time for Zero Fuel Calibration is  $< 10\text{ ms}$  or  $> 850\text{ ms}$  (beyond limits for P02CC-P02DA) OR The difference between programmed energizing time and actual energizing time exceeds  $127.2\text{ us}$  or The requested time for start of energizing of a given fuel injection is outside the crank angle regime permitted for that injection

OR The correction in requested fuel injection quantity due to transient pressure effects within the fuel injector as calculated by the control software and as calculated by the monitor exceeds  $5\text{ mg}$  for an injection

P061C – The engine speed calculated by the control software and the engine speed calculated by the monitor deviate by more than  $400\text{ RPM}$

P062B – If an error is detected in a requested post injection OR If requested energizing time exceeds  $200\text{ us}$  when the controller is operating in overrun/decel fuel shut-off mode

P062F – An error is detected in an EEPROM read, write, or erase operation

P06A6 – Voltage output of sensor supply 1 is  $< 4.7\text{ V}$  or  $> 5.3\text{ V}$

P06A7 – Voltage output of sensor supply 2 is  $< 4.7\text{ V}$  or  $> 5.3\text{ V}$

P06A8 – Voltage output of sensor supply 3  $< 4.7\text{ V}$  or  $> 5.3\text{ V}$

P167F – a non-OEM calibration has been detected

P2507 – The 5V internal ECU supply is  $< 4.2\text{ V}$

P2508 – The 5V internal ECU supply is  $> 5.5\text{ V}$

P2610 – If, during a key off event, engine coolant temperature decreases by  $30\text{ degrees}$  and the engine off timer has not incremented at least  $1200\text{ seconds}$  OR If, while running for  $1200\text{ seconds}$  as measured by ECU timer, the timer used for engine off time and the time as determined by the secondary timer differ by at least  $100\text{ seconds}$  OR In afterrun, if a requested  $8\text{ second}$  stop timer measurement is  $< 7.52\text{ seconds}$  or  $> 8.48\text{ seconds}$

<b>Idle Speed and Fuel Monitor Operation:</b>	
DTCs	P0506 - Idle Control System - RPM Lower Than Expected P0507 - Idle Control System - RPM Higher Than Expected P054E - Idle Control System - Fuel Quantity Lower Than Expected P054F - Idle Control System - Fuel Quantity Higher Than Expected
Monitor Execution	P0506, P0507, P054E, P054F - Continuous
Monitor Sequence	None
Sensors OK	P0506 - Engine Coolant Temperature (P0116, P0117, P0118, P0128, Crankshaft Sensor (P0335, P0336), P0507 - Engine Coolant Temperature (P0116, P0117, P0118, P0128, Crankshaft Sensor (P0335, P0336), P054E - Engine Coolant Temperature (P0116, P0117, P0118, P0128, Crankshaft Sensor (P0335, P0336), P054F - Engine Coolant Temperature (P0116, P0117, P0118, P0128, , Crankshaft Sensor (P0335, P0336),
Typical Monitoring Duration	P0506 – 5 sec P0507 – 5 sec P054E – 5 sec P054F – 5 sec

<b>Typical Idle Speed and Fuel Monitor Entry Conditions:</b>		
Entry condition	Minimum	Maximum
P0506, P0507:		
Engine idle speed governor active		
Engine Coolant Temperature (°C)	0	120
Vehicle Speed (kph)		1
Engine RPM	300 (stall speed)	1500 (300 rpm above max requestable idle speed)
P054E, P054F:		
Engine running		

<b>Typical Idle Speed and Fuel Monitor Malfunction Thresholds:</b>
P0506 – If observed idle speed is 100 or more RPM below requested idle speed
P0507 – If observed idle speed is 160 or more RPM above requested idle speed
P054E – If calculated torque required for idle is 30+% below the minimum threshold of 10 Nm
P054F – If calculated torque required for idle is 30+% above the maximum of threshold of 120 Nm

## Lack of Communication Codes:

### CAN Communications Error

The TCM receives information from the ECM via the high speed CAN network. If the CAN link or network fails, the TCM no longer has torque or engine speed information available. The TCM will store a U0073 fault code and will illuminate the MIL immediately (missing engine speed) if the CAN Bus is off. The TCM will store a U0100 fault code and will illuminate the MIL immediately (missing engine speed) if it stops receiving CAN messages from the ECM.

ECU CAN Communication Malfunctions	
DTCs	U0073 - Control Module Communication Bus "A" Off U0074 - Control Module Communication Bus "B" Off U0101 - Lost Communication with TCM U0102 - Lost Communication with Transfer Case Control Module U0121 - Lost Communication With Anti-Lock Brake System (ABS) Control Module U0151 - Lost Communication With Restraints Control Module U0212 - Lost Communication With Steering Column Control Module U029D - Lost Communication With NOx Sensor "A" U029E - Lost Communication With NOx Sensor "B" U0307 - Software Incompatibility with Glow Plug Control Module U0407 - Invalid Data Received from Glow Control Module U059E - Invalid Data Received from NOx Sensor "A" U059F - Invalid Data Received from NOx Sensor "B" U0002 - High Speed CAN Communication Bus Performance U1013 - Invalid Internal Control Module Monitoring Data Received from TCM
Monitor execution	continuous
Monitor Sequence	None
Sensors OK	not applicable
Monitoring Duration	continuous

### Typical Malfunction Thresholds

U0073 CAN Chip Driver detect CAN line short or open > 10 ms  
U0074 CAN Chip Driver detect CAN line short or open > 10 ms  
U0101 TCM master message not received for 1 sec  
U0102 TCCM master message not received for 5 sec  
U0121 ABS master message not received for 5 sec  
U0151 RCM master message not received for 10 sec  
U0212 SCCM master message not received for 5 sec  
U029D NOx sensor master message not received for .75 sec  
U029E NOx sensor master message not received for .75 sec  
U0307 – Glow module reporting "safe glow" mode  
U0407 - Calibration Verification Number not received by ECU  
U059E - Calibration Verification Number not received by ECU  
U0002 - ECM transmit CAN buffer overload > 5 sec  
U1013 – invalid data received from TCM > 5 sec

Vehicle speed is received by the ECU over CAN from the ABS system or (if the ABS system is faulted on all 4 wheel speed sensors) the TCU through Output Shaft Speed calculation to wheel speed

### VS Communication Plausibility Malfunctions

DTCs	P0500 Vehicle Speed Sensor "A"
Monitor execution	continuous
Monitor Sequence	None
Sensors OK	not applicable
Monitoring Duration	continuous

### Typical Malfunction Thresholds

VS signal is missing from the CAN system for 0.5 Seconds.

## Glow Plugs and Glow Plug Control Modujle (GPCM)

The diesel engine uses glow plugs to assist with cold weather starting and combustion until the cylinder is warm enough to operate normally. The glow plugs are duty cycle controlled and will overheat if constant 12V is applied.

The glow plugs are operated by the Glow Plug Control Module (GPCM). It contains 8 high current smart MOSFET drivers, one for each glow plug. Glow time and intensity are calculated on the basis of CAN signals (rpm, torque, engine coolant temp, air temp and BARO.) The module also contains 3 drivers for the DEF (NOx reductant) heating and thawing system.

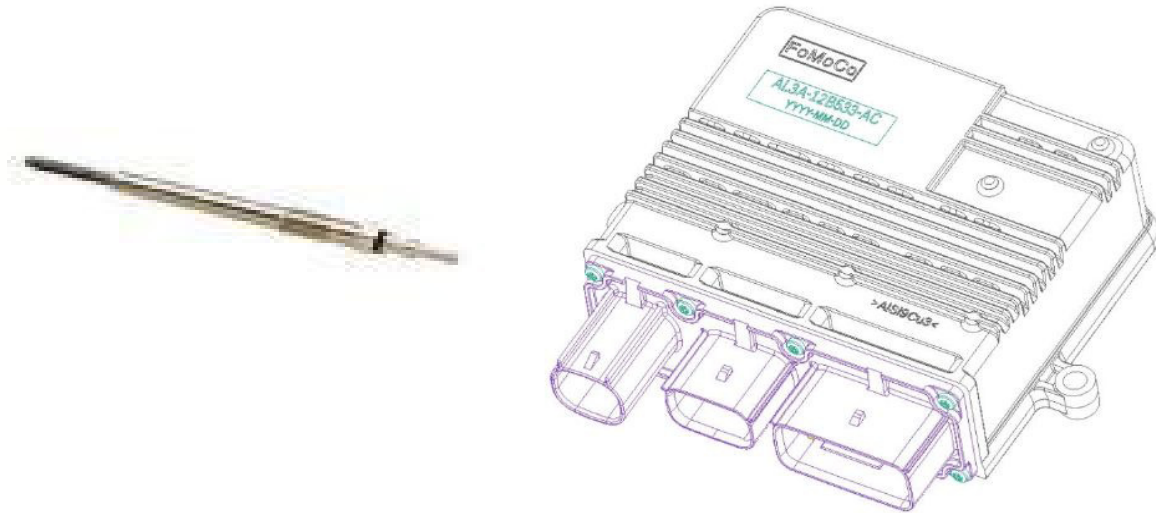

### Glow Plug and Glow Plug Control Module (GPM)

The GPCM is connected to the ECU via Diesel high speed CAN. All data and diagnostics pass over this non-public communication bus. The standard operating voltages for the GPCM are 6.5 volts to 16 volts. Limited operation between 5.5v and 6.5v on the lower range and no operation below 5.5v. Glow function is disabled below 6.5v and above 16.5v.

Glow Plug Module Operational Checks:	
DTCs	U0106 – Lost Communication with GPCM P0381 – Glow Plug/Heater Indicator Circuit P064C – Glow Plug Control Module P06DF – Glow Plug Module Memory Checksum Error P138B – Glow Plug Module System Voltage P20C2 – Reductant Heater "C" Control Performance P263C - Glow Plug Driver Performance P06E5 - Glow Plug Control Module 1 Performance P263E - Glow Plug Control Module 1 Over Temperature
Monitor execution	P06DF, P0381 at power up, otherwise continuous
Monitor Sequence	none
Sensors OK	none
Monitoring Duration	~1 second to register a malfunction

**Glow Plug Module: Malfunction Thresholds:**

Communication lost for > 5 seconds

Cluster detects wait to start lamp in wrong state (off when commanded on)

Any internal driver circuits detect fault (not switching or over temp) > 1 sec (glow plugs, urea heaters or relay)

RAM checksums do not match expected

GPCM main power feed voltage too low / too high / open circuit (< 6.5 volts or > 16 volts)

Low voltage detected on the Reductant Heater Circuit "C" < 5 volts

**Glow Plug Circuit Open Load Check Operation:**

DTCs	P0671 – Cylinder 1 Glow Plug Circuit / Open P0672 – Cylinder 2 Glow Plug Circuit / Open P0673 – Cylinder 3 Glow Plug Circuit / Open P0674 – Cylinder 4 Glow Plug Circuit / Open P0675 – Cylinder 5 Glow Plug Circuit / Open P0676 – Cylinder 6 Glow Plug Circuit / Open P0677 – Cylinder 7 Glow Plug Circuit / Open P0678 – Cylinder 8 Glow Plug Circuit / Open P20B9 – Reductant Heater "A" Control Circuit / Open P20BD – Reductant Heater "B" Control Circuit / Open P20C1 – Reductant Heater "C" Control Circuit / Open
Monitor execution	Glow plugs in heating mode. Heaters operational
Monitor Sequence	none
Sensors OK	none
Monitoring Duration	~1 second to register a malfunction

**Glow Plug Circuit Open Load: Malfunction Thresholds:**

Individual glow plug circuit current < 1 A, Individual reductant heater circuit current < .2 A

**Glow Plug Circuit Short to Battery Check Operation:**

DTCs	P066B – Cylinder 1 Glow Plug Circuit High P066D – Cylinder 2 Glow Plug Circuit High P066F – Cylinder 3 Glow Plug Circuit High P067B – Cylinder 4 Glow Plug Circuit High P067D – Cylinder 5 Glow Plug Circuit High P067F – Cylinder 6 Glow Plug Circuit High P068D – Cylinder 7 Glow Plug Circuit High P068F – Cylinder 8 Glow Plug Circuit High P20BC – Reductant Heater "A" Control Circuit High P20C0 – Reductant Heater "B" Control Circuit High P20C4 – Reductant Heater "C" Control Circuit High
Monitor execution	Glow plugs in heating mode. Heaters operational
Monitor Sequence	none
Sensors OK	none
Monitoring Duration	~1 second to register a malfunction for glow plugs 250 ms to register a malfunction for the reductant heaters

**Glow Plug Circuit Short to Battery: Malfunction Thresholds:**

Individual glow plug circuit = 0 Amps current, Individual reductant heater circuit = 0 Amps current

**Glow Plug Circuit Short to Ground Check Operation:**

DTCs	P066A – Cylinder 1 Glow Plug Circuit Low P066C – Cylinder 2 Glow Plug Circuit Low P066E – Cylinder 3 Glow Plug Circuit Low P067A – Cylinder 4 Glow Plug Circuit Low P067C – Cylinder 5 Glow Plug Circuit Low P067E – Cylinder 6 Glow Plug Circuit Low P068C – Cylinder 7 Glow Plug Circuit Low P068E – Cylinder 8 Glow Plug Circuit Low P20BB – Reductant Heater "A" Control Circuit Low P20BF – Reductant Heater "B" Control Circuit Low P20C3 – Reductant Heater "C" Control Circuit Low
Monitor execution	Glow plugs in heating mode. Heaters operational.
Monitor Sequence	none
Sensors OK	none
Monitoring Duration	~3 second to register a malfunction for glow plugs 250 ms to register a malfunction for the reductant heaters

**Glow Plug Circuit Short to Battery: Malfunction Thresholds:**

Individual glow plug circuit > 20 Amps current > 1 second  
Individual glow plug circuit > 70 Amps current for > .2 ms  
Reductant heater relay (circuit "A" & "B") > 15 Amps current > 250 ms  
Reductant heater relay (circuit "C") > 6 Amps current > 250 ms

**Glow Plug Circuit Resistance Out of Range Check:**

DTCs	P06B9 – Cylinder 1 Glow Plug Circuit Range / Performance P06BA – Cylinder 2 Glow Plug Circuit Range / Performance P06BB – Cylinder 3 Glow Plug Circuit Range / Performance P06BC – Cylinder 4 Glow Plug Circuit Range / Performance P06BD – Cylinder 5 Glow Plug Circuit Range / Performance P06BE – Cylinder 6 Glow Plug Circuit Range / Performance P06BF – Cylinder 7 Glow Plug Circuit Range / Performance P06C0 – Cylinder 8 Glow Plug Circuit Range / Performance
Monitor execution	Glow plugs in heating mode.
Monitor Sequence	After Open circuit, short to battery and short to ground testing
Sensors OK	none
Monitoring Duration	~3 second to register a malfunction

**Glow Plug Circuit Short to Battery: Malfunction Thresholds:**

Individual circuit > 2 ohms resistance



## Down Stream Injection (DSI) System

Down Stream Injection [DSI] system (that includes Vaporizer Pump and Glow Plug) is used to aid in DPF regeneration on the 3.2L engine so as to reduce oil dilution associated with in-cylinder post injections.

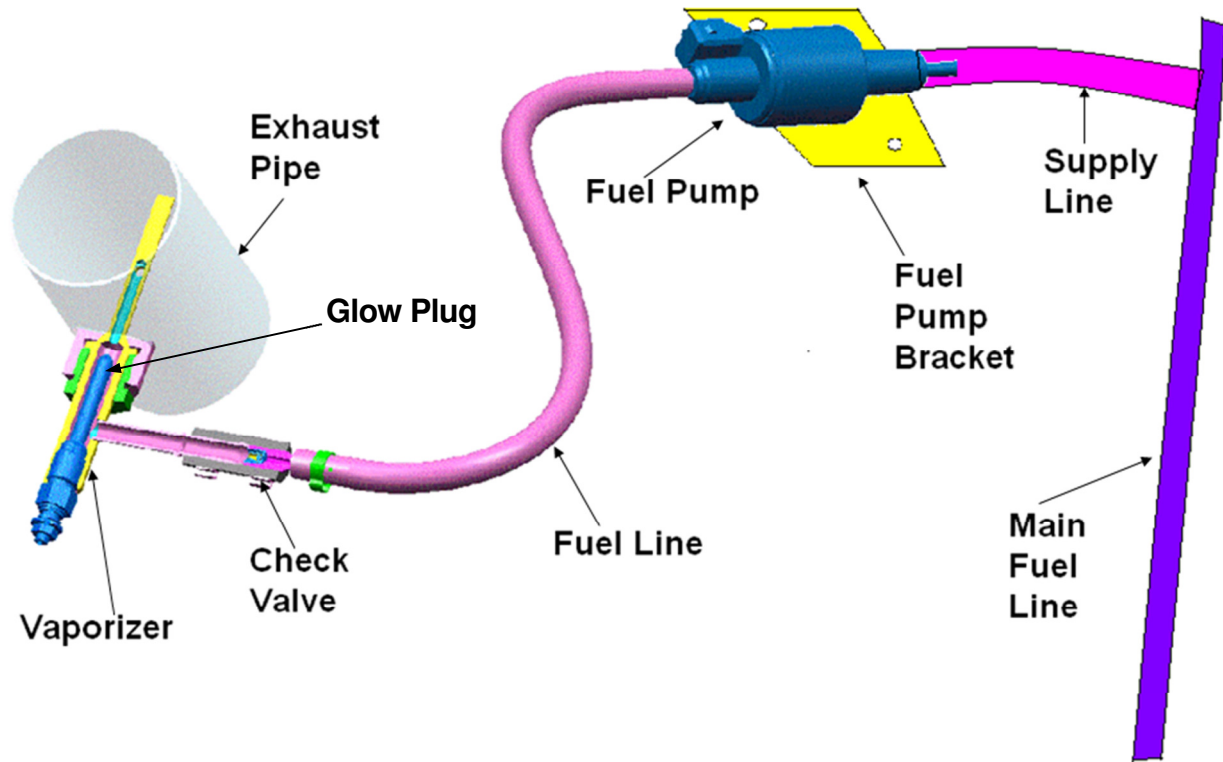

DSI monitoring strategy includes circuit continuity checks for vaporizer pump and vaporizer glow plug, plausibility check for vaporizer glow plug relay, and DSI leakage monitor.

### DSI Vaporizer Pump Circuit Continuity Check Monitor

Vaporizer pump circuit continuity check is performed continuously during each drive cycle. It compares the pump voltage output with minimum/maximum allowable voltage threshold. If vaporizer pump voltage is detected outside of the threshold range, it detects fault.

#### DSI Vaporizer Pump Circuit Continuity Check:

DTCs	P20CB - Exhaust Aftertreatment Fuel Injector "A" Control Circuit/Open P20CD - Exhaust Aftertreatment Fuel Injector "A" Control Circuit Low P20CE - Exhaust Aftertreatment Fuel Injector "A" Control Circuit High
Monitor Execution	Continuous (while entry conditions are met)
Monitor Sequence	None
Sensors OK	Not applicable
Typical Monitoring Duration	5 sec.

Typical DSI Vaporizer Pump Circuit Continuity Check Entry Conditions:		
Entry Condition	Minimum	Maximum
Battery Voltage	9.0 V	16.3 V
Key On		

Typical DSI Vaporizer Pump Circuit Continuity Check Malfunction Thresholds:
<b>Open Circuit Voltage Threshold:</b> If $2.9\text{ V} < \text{Vaporizer Pump Voltage} < 3.2\text{ V}$ for 5 seconds, the open circuit fault is detected.
<b>Short to Ground Voltage Threshold:</b> If $1.95\text{ V} < \text{Vaporizer Pump Voltage} < 2.175\text{ V}$ for 5 seconds, the short to ground fault is detected.
<b>Short to Positive/Battery Voltage Threshold:</b> If $10.9\text{ V} < \text{Vaporizer Pump Voltage} < 12.32\text{ V}$ for 5 seconds, the short to battery fault is detected.

### DSI Vaporizer Glow Plug Circuit Continuity Check Monitor

Vaporizer Glow Plug circuit continuity check is performed continuously during each drive cycle. It compares the glow plug voltage output with minimum/maximum allowable voltage threshold. If vaporizer glow plug voltage is detected outside of the threshold range, it detects fault.

DSI Vaporizer Glow Plug Circuit Continuity Check:	
DTCs	P2687 – Fuel Supply Heater Control Circuit/Open P2688 – Fuel Supply Heater Control Circuit Low P2689 – Fuel Supply Heater Control Circuit High
Monitor Execution	Continuous (while entry conditions are met)
Monitor Sequence	None
Sensors OK	Not applicable
Typical Monitoring Duration	5 sec.

Typical DSI Vaporizer Glow Plug Circuit Continuity Check Entry Conditions:		
Entry Condition	Minimum	Maximum
Battery Voltage	9.0 V	16.3 V
Key On		
Typical DSI Vaporizer Glow Plug Circuit Continuity Check Malfunction Thresholds:		
<b>Open Circuit Voltage Threshold:</b> If $2.9\text{ V} < \text{Vaporizer Glow Plug Voltage} < 3.2\text{ V}$ for 5 seconds, the open circuit fault is detected.		
<b>Short to Ground Voltage Threshold:</b> If $1.95\text{ V} < \text{Vaporizer Glow Plug Voltage} < 2.175\text{ V}$ for 5 seconds, the short to ground fault is detected.		
<b>Short to Positive/Battery Voltage Threshold:</b> If $10.9\text{ V} < \text{Vaporizer Glow Plug Voltage} < 12.32\text{ V}$ for 5 seconds, the short to battery fault is detected.		

## DSI Vaporizer Glow Plug Relay Plausibility Check Monitor

Vaporizer Glow Plug Relay plausibility check is performed continuously during each drive cycle. If vaporizer glow plug relay feedback state doesn't match the relay command state, it detects fault.

DSI Vaporizer Glow Plug Relay Plausibility Check:	
DTCs	P2689 – Fuel Supply Heater Control Circuit High <i>[this P-Code may change later]</i>
Monitor Execution	Continuous (while entry conditions are met)
Monitor Sequence	None
Sensors OK	DSI Glow Plug
Typical Monitoring Duration	60 sec.

Typical DSI Vaporizer Glow Plug Relay Plausibility Check Entry Conditions:		
Entry Condition	Minimum	Maximum
Battery Voltage	9.0 V	16.3 V
Key On		

Typical Vaporizer Glow Plug Relay Plausibility Check Malfunction Thresholds:
If Glow Plug Relay Feedback $\neq$ Glow Plug Relay Command for approx 60 seconds, the fault is detected.

## DSI Leakage Monitor

DSI leakage monitor addresses the detection of a leaking DSI system in normal lean condition when it is not supposed to dispense fuel to exhaust pipe. DSI monitoring during normal operation is achieved through exhaust temperature feedbacks. DSI leakage is detected by comparing measured post-SBS temperature with a modeled post-SBS temperature value under enable conditions. If the difference between post-SBS temperature and model temperature exceeds certain threshold, DSI system detects leakage fault.

DSI Leakage Monitor:		
DTCs	P20CC - Exhaust Aftertreatment Fuel Injector "A" Control Performance	
Monitor Execution	Continuous at Normal Operating Mode (while entry conditions are met)	
Monitor Sequence	None	
Sensors OK	Pre-SBS EGT, Post-SBS EGT.	
Typical Monitoring Duration	10 seconds	
Typical DSI Leakage Monitor Entry Conditions:		
Entry Condition	Minimum	Maximum
Intake Air Mass Flow	N/A	400 kg/hour
Engine Speed	0 RPM	2000 RPM
Engine Torque	0 N-m	350 N-m
Post SBS Exhaust Gas Temperature	200 Deg_C	N/A
Pre SBS Exhaust Gas Temperature	190 Deg_C	550 Deg_C
Ambient Air Temperature	0 Deg_C	N/A
Engine Temperature	10 Deg_C	N/A
Ambient Air Pressure	800 hPa	N/A
Engine Off Time	6 Hours	N/A
Key On		
Engine is Running		

Typical DSI Leakage Monitor Malfunction Thresholds:
While all entry conditions met, if the difference between post SBS model temperature and actual temperature exceeds 58 Deg_C for 10 seconds; DSI leakage fault is detected.

## Turbocharger Actuator Signal Range Check

The diagnostics for the circuit range check on the pwm signal to the turbocharger VGT actuator are internal to the PWM power-stage. Open load, short-circuit to ground, and short-circuit to battery are detected on the single control line to the actuator.

<b>Turbocharger Control Circuit Open Load/Short to Ground/Short to Power:</b>	
DTCs	P132A - Turbocharger/Supercharger Boost Control "A" Electrical
Monitor execution	Continuous
Monitor Sequence	None
Monitoring Duration	2 seconds to register a malfunction

## Miscellaneous ECU Faults:

### Vehicle Configuration Information

Vehicle specific information is stored in two locations: the VID block within the ECU and within the body control module (BCM). The following fault codes are immediate malfunction lamp codes (1 drive cycle) and reflect that the vehicle configuration information has been improperly configured.

VID Block Configuration	
DTCs	P0602 - Internal Control Module Keep Alive Memory (KAM) Error P0610 - Control Module Vehicle Options Error P0630 - VIN Not Programmed or Incompatible - ECM/PCM P1639 - Vehicle ID Block Corrupted, Not Programmed P264F - Engine Serial Number Not Programmed or Incompatible

ECU Main Relay	
DTCs	P0685 - ECM/PCM Power Relay Control Circuit/Open P068A – ECM/PCM Power Relay De-Energized Too Early
Monitor execution	Continuous
Monitor Sequence	None
Monitoring Duration	0.5 seconds to register a malfunction.

### Transmission Park/Neutral Gear Check at Start-Up

There are two inputs to the ECM for park/neutral gear determination, a hardwired input and a CAN input. If the hardwired input does not agree with the CAN input when the starter motor is requested (key in crank position), a DTC is set.

Transmission Park/Neutral Switch Plausibility Check:	
DTCs	P0850 – Park / Neutral Switch Input Circuit
Monitor execution	Continuous
Monitor Sequence	None
Monitoring Duration	1 second to register a malfunction.

# Comprehensive Component Monitor - Transmission

## General

The MIL is illuminated for all emissions related electrical component malfunctions. For malfunctions attributable to a mechanical component (such as a clutch, gear, band, valve, etc.), some transmissions are capable of not commanding the mechanically failed component and providing the remaining maximum functionality (functionality is reassessed on each power up)- in such case a non-MIL Diagnostic Trouble Code (DTC) will be stored and, if so equipped, the Wrench" Light will flash.

## Transmission Inputs

Transmission Range Sensor Check Operation:	
DTCs	P0706 - Out of range signal frequency for PWM TRS P0707, P0708 - Low /High duty cycle for PWM TRS
Monitor execution	Continuous
Monitor Sequence	None
Sensors OK	
Monitoring Duration	5 seconds of signal out of range

Typical TRS check entry conditions:		
Auto Transmission Entry Conditions	Minimum	Maximum
battery voltage	7v	18v

Typical TRS malfunction thresholds:
PWM TRS: Frequency > 175 Hz or < 75 Hz, Duty Cycle > 90% or < 10%

Output Shaft Speed Sensor Functional Check Operation:	
DTCs	P0720 – OSS circuit P0722 – OSS no signal
Monitor execution	Continuous
Monitor Sequence	None
Sensors OK	TSS, Wheel Speed
Monitoring Duration	30 seconds

**Typical OSS functional check entry conditions:**

Auto Transmission Entry Conditions	Minimum	Maximum
Gear selector position	drive	
Engine rpm (above converter stall speed) OR	3000 rpm	
Turbine shaft rpm (if available) OR	1500 rpm	
Output shaft rpm	300 - 650 rpm	
Vehicle speed (if available)	12.5 - 15 mph	

**Typical OSS functional check malfunction thresholds:**

Circuit/no signal - vehicle is inferred to be moving with positive driving torque and OSS < 100 to 200 rpm for 5 to 30 seconds

**Turbine Shaft Speed Sensor Functional Check Operation:**

DTCs	P0715 – TSS circuit P0717 – TSS no signal
Monitor execution	Continuous
Monitor Sequence	None
Sensors OK	OSS, Wheel Speed
Monitoring Duration	30 seconds

**Typical TSS functional check entry conditions:**

Auto Transmission Entry Conditions	Minimum	Maximum
Gear selector position	Forward range	
Engine rpm (above converter stall speed) OR	3000 rpm	
Output shaft rpm OR	600 - 650 rpm	
Vehicle speed (if available)	12.5 - 15 mph	

**Typical TSS functional check malfunction thresholds:**

Circuit/no signal - vehicle is inferred to be moving with positive driving torque and TSS < 200 rpm for 5 – 30 seconds

**System voltage:**

DTCs	P0882 – voltage out of range low P0883 – voltage out of range high
Monitoring execution	electrical - continuous



<b>Transmission Fluid Temperature Sensor Functional Check Operation:</b>	
DTCs (non-MIL)	P0712, P0713 or P0710 - Opens/shorts P1711 – in range failures P1783 – Transmission overtemperature (non-MIL fault, TFT > 275 deg F for 5 seconds)
Monitor execution	continuous
Monitor Sequence	none
Sensors OK	ECT substituted if TFT has malfunction
Monitoring Duration	5 seconds for electrical, 600 seconds for functional check

<b>Typical TFT Stuck Low/High check entry conditions:</b>		
Auto Transmission Entry Conditions	Minimum	Maximum
Engine Coolant Temp (hot or cold, not midrange)	> 100 °F	< 20 °F
Time in run mode	500 – 600 sec	
Time in gear, vehicle moving, positive torque	150 sec	
Vehicle Speed	15 mph	
Time with engine off (cold start) OR	420 min	
Engine Coolant Temp AND Trans Fluid Temp (inferred cold start)		122 °F

<b>Typical TFT malfunction thresholds:</b>
Opens/shorts: TFT voltage <0.05 or > 4.6 volts for 5 – 12 seconds
TFT Stuck low/high, i.e. TFT stuck at high temperature or stuck at low temperature):
Stores a fault code if TFT stabilizes (stops increasing if temperature < 70 deg F, stops decreasing if temperature > 225 deg F) before reaching the temperature region where all MIL tests are enabled (70 to 225 deg F). If TFT remains constant (+/- 2 deg F) for approximately 2.5 minutes of vehicle driving outside the 70 to 225 deg F zone a P0711 fault code will be stored. Old logic used to indicate a "pass" for a single delta, and not test until the normal operating region (70-225 deg F) was reached.

<b>CAN:</b>	
DTCs	U0073 – CAN bus off U0100 – Lost communication with ECM
Monitoring execution	Continuous
Monitoring sequence	none

## Transmission Outputs

Transmission Solenoid Power Control (TSPC – provides power to all transmission solenoids:	
DTCs	P0657 – TSPC1 fault, impacts SSA, SSC, SSE P2669 – TSPC2 fault, impacts SSB, SSD, TCC and LPC
Monitoring execution	electrical - continuous
Monitor sequence	Disables individual solenoid circuit fault detection if either above DTC sets and power is removed from all solenoids (one relay, removes power from both TSPC1 and TSPC2 wires)

Shift Solenoid Check Operation:	
DTCs	<p>SS A - Electrical: P0750 (Open), P0973 (short to ground), P0974 (short to power) Functional: P0751 (stuck off), P0752 (stuck on)</p> <p>SS B - Electrical: P0755 (Open), P0976 (short to ground), P0977 (short to power) Functional: P0756 (stuck off), P0757 (stuck on)</p> <p>SS C - Electrical: P0760 (Open), P0979 (short to ground), P0980 (short to power) Functional: P0761 (stuck off), P0762 (stuck on)</p> <p>SS D - Electrical: P0765 (Open), P0982 (short to ground), P0983 (short to power) Functional: P0766 (stuck off), P0767 (stuck on)</p> <p>SS E - Electrical: P0770 (Open), P0985 (short to ground), P0986 (short to power) Functional: P0771 (stuck off), P0772 (stuck on)</p>
Monitor execution	electrical - continuous, functional - continuous
Monitor Sequence	None
Sensors OK	TRS, TSS and OSS ok for functional diagnostics
Monitoring Duration	0.5 to 5 seconds for electrical checks, 3 clutch failed to apply (stuck off) or release (stuck on) events for functional check

Typical Shift Solenoid mechanical functional check entry conditions:		
Entry Conditions (with turbine speed)	Minimum	Maximum
Gear ratio calculated	each gear	
Throttle position	positive drive torque	

**Typical Shift Solenoid mechanical functional check entry conditions:**

Entry Conditions (without turbine speed)	Minimum	Maximum
Rpm drop is obtained	each shift	
Throttle position	positive drive torque	

**Typical Shift Solenoid malfunction thresholds:**

Electrical circuit check: Output driver feedback indicates an open, short to ground or open circuit for 0.5 – 5.0 seconds

**Gear Ratio Check Operation:**

DTCs	P0731 - incorrect gear 1 ratio P0732 - incorrect gear 2 ratio P0733 - incorrect gear 3 ratio P0734 - incorrect gear 4 ratio P0735 - incorrect gear 5 ratio P0729 - incorrect gear 6 ratio P0736 - incorrect reverse ratio 6
Monitor execution	Continuous, in each gear
Monitor Sequence	None
Sensors OK	TSS, OSS, wheel speed
Monitoring Duration	12 seconds

**Typical Forward Gear Ratio check entry conditions:**

Entry Conditions	Minimum	Maximum
Gear selector position	forward range, > 8 seconds	
Engine Torque	100 NM	
Throttle position	10%	
Not shifting	> 0.5 seconds	
Engine/input Speed	550 rpm	
Output Shaft Speed	250 rpm	1350 rpm

**Typical Neutral Gear Ratio check entry conditions:**

Entry Conditions	Minimum	Maximum
Gear selector position	forward range, > 1 second	
Absolute value of Engine rpm – Turbine rpm		150 rpm
Output Shaft Speed		500 rpm

**Typical Gear Ratio malfunction thresholds:**

Forward gear check: > 20% error in commanded ratio for > 12 seconds

**Typical Shift Completion check entry conditions:**

Entry Conditions	Minimum	Maximum
Gear selector position	forward range	
Transmission Fluid Temp	50 °F	
Engine/input Speed	1200 rpm	
Output Shaft Speed	256 rpm	

**Typical Shift Completion malfunction thresholds:**

Up-shift rpm check: rpm does not drop by > 30 rpm

Down-shift rpm check: rpm does not increase by > 30 rpm

Up-shift rpm check: rpm increases (flares) by > 300 rpm

<b>Torque Converter Clutch Check Operation:</b>	
DTCs	Electrical: P0740 (open), P0742 (short to ground), P0744 (short to power) Functional: P0741 (stuck off), P2758 (stuck on) Note: P2758 is non-MIL, all other TCC DTC's are MIL
Monitor execution	electrical - continuous, mechanical - TCC fails to apply 3 times (stuck off) or fails to release 3 times (stuck on)
Monitor Sequence	None
Sensors OK	TSS, OSS
Monitoring Duration	Electrical – 5 seconds, Functional - 3 lock-up or release events

<b>Typical TCC mechanical functional check stuck off entry conditions:</b>		
Entry Conditions	Minimum	Maximum
Throttle Position	steady	
Engine Torque	positive drive torque	
Transmission Fluid Temp	70 °F	225 °F
Commanded TCC pressure (0 rpm slip)	55 psi	none
Not shifting		

<b>Typical TCC malfunction thresholds:</b>
Electrical circuit check: Output driver feedback circuit does not match commanded driver state for 0.5 – 5.0 seconds Mechanical check, stuck off: Slip across torque converter > 100 for 3 seconds after each of 3 lock events Mechanical check, stuck on: Slip across torque converter < 20 rpm with converter commanded off in at least 3 different gears

<b>Pressure Control Solenoid Check Operation:</b>	
DTCs	P0960, P0962, P0963 - PC A opens/shorts P0961 - PC A current range
Monitor execution	Continuous
Monitor Sequence	none
Sensors OK	
Monitoring Duration	Electrical: 5 seconds,

<b>Typical Pressure Control Solenoid mechanical functional check entry conditions:</b>		
Entry Conditions	Minimum	Maximum
Gear ratio calculated	each gear	
Transmission Fluid Temperature	70 °F	225 °F
Throttle Position	positive drive torque	

<b>Typical Pressure Control Solenoid malfunction thresholds:</b>	
Electrical circuit check: Output driver feedback circuit does not match commanded driver state for 0.5 – 5.0 seconds	
Electrical current check: Feedback current out of range for 0.5 seconds	

## **Transmission Control Module (TCM)**

<b>TCM</b>	
DTCs	P0604 – RAM fault present P0605 – ROM fault present P0607 – CPU reset fault P06B8 – NVRAM error
Monitoring execution	Once per driving cycle at start-up except reset monitoring which is continuous
Monitor sequence	non

<b>ADLER (chip that controls the transmission solenoids):</b>	
DTCs	P1636 – lost communication (over internal SPI network) with ADLER chip
Monitoring execution	electrical - continuous
Monitor sequence	Transmission enters mechanical limp home (get P, R, N and 5M with open TCC and max line) if the main micro cannot communicate with the ADLER chip

**Transmission ID (TRID) block (contains solenoid characterization data)**

DTCs	P163E – programming error (checksum fault) P163F – TRID data not programmed
Monitoring execution	Start-up – TRID is a portion of flash memory, either it is present at start-up or not
Monitor sequence	Transmission solenoid data missing, enters limited operating mode (P, R, N and 3 <sup>rd</sup> gear with open TCC).

## **6R140 (RWD) Transmission with external PCM or TCM**

### **Transmission Control System Architecture**

Starting in 2011 MY 6R140 replaces 5R110W in Super Duty truck applications.

The 6R140 is a 6-speed, step ratio transmission that is controlled by an external PCM (gas engine applications) or TCM (Diesel engine applications). For Diesel the TCM communicates to the Engine Control Module (ECM), ABS Module, Instrument Cluster and Transfer Case Control Module using the high speed CAN communication link. The TCM incorporates a standalone OBD-II system. The TCM independently processes and stores fault codes, freeze frame, supports industry-standard PIDs as well as J1979 Mode 09 CALID and CVN. The TCM does not directly illuminate the MIL, but requests the ECM to do so. The TCM is located outside the transmission assembly. It is not serviceable with the exception of reprogramming.

### **Transmission Inputs**

#### **Transmission Range Sensor**

6R140 uses a Non-contacting Pulse Width Modulated Transmission Range Sensor (TRS) that provides a duty cycle signal for each position. This signal is transmitted at a frequency of 125 Hz. The PCM / TCM decode the duty cycle to determine the driver-selected gear position (Park, Rev, Neutral, OD, 3, 2, 1). This input device is checked for frequency out of range (P0706), duty cycle out of range low (P0707) and duty cycle out of range high (P0708)

#### **Speed Sensors**

The Turbine Shaft Speed (TSS) sensor and Output Shaft Speed (OSS) sensor are Hall effect sensors.

The Turbine Shaft Speed sensor is monitored by a rationality test, if engine speed and output shaft speed are high and a gear is engaged, it can be inferred that the vehicle is moving. If there is insufficient output from the TSS sensor a fault is stored (P0715).

The Output Shaft Speed sensor is monitored by a rationality test. If engine speed and turbine speed are high and a gear is engaged, it can be inferred that the vehicle is moving. If there is insufficient output from the OSS sensor a fault is stored (P0720).

#### **Transmission Fluid Temperature**

The Transmission Fluid Temperature Sensor is checked for out of range low (P0712), out of range high (P0713), and in-range failures (P0711). P1783 sets if TFT exceeds 275 deg F for 5 seconds, indicating transmission overtemperature (non-MIL failure).



## Transmission Outputs

### Shift Solenoids (SS)

6R140 has 5 shift solenoids:

- SSA – a Variable Force Solenoid (VFS) that controls CB1234 (a brake clutch, grounds an element to the case, that is on in 1<sup>st</sup>, 2<sup>nd</sup>, 3<sup>rd</sup> and 4<sup>th</sup> gear)
- SSB – a VFS that controls C35R (a rotating clutch on in 3<sup>rd</sup>, 5<sup>th</sup> and Reverse)
- SSC – a VFS that controls CB26 (a brake clutch on in 2<sup>nd</sup> and 6<sup>th</sup> gear)
- SSD – a VFS that controls CBLR (a brake clutch on in 1<sup>st</sup> gear with engine braking and Reverse)
- SSE – a VFS that controls C456 (a rotating clutch on in 4<sup>th</sup>, 5<sup>th</sup> and 6<sup>th</sup> gear)

Output circuits are checked for opens, short to ground and short to power faults (codes listed in that order) by the "smart driver" (see ADLER below) that controls the solenoids (SSA P0750, P0973, P0974; SSB P0755, P0976, P0977; SSC P0760, P0979, P0980; SSD P0765, P0982, P0983; SSE P0770, P0985, P0986).

The shift solenoids are also functional tested for stuck on and stuck off failures. This is determined by vehicle inputs such as gear command, and achieved gear (based on turbine and output speed). In general the shift solenoid malfunction codes actually cover the entire clutch system (solenoid, valves, seals and the clutch itself since using ratio there is no way to isolate the solenoid from the rest of the clutch system)

For SSA thru SSE Diagnostics will isolate the fault into clutch functionally (non-electrical) failed off (SSA P0751, SSB P0756, SSC P0761, SSD P0766. SSE P0771) and clutch functionally failed on (SSA: P0752, SSB: P0757, SSC: P0762, SSD: P0767, SSE: P0772).

### Gear ratio errors:

If ratio errors are detected that do not match an expected pattern for a failed solenoid then gear ratio error fault codes (1<sup>st</sup> gear – P0731, 2<sup>nd</sup> gear – P0732, 3<sup>rd</sup> gear – P0733, 4<sup>th</sup> gear – P0734, 5<sup>th</sup> gear – P0735 or 6<sup>th</sup> gear – P0729) will be stored.

### Torque Converter Clutch

The Torque Converter Clutch (TCC) solenoid is a Variable Force Solenoid. TCC solenoid circuit is checked electrically for open, short to ground and short to power circuit faults internally by the "smart driver" that controls the solenoids (P0740, P0742, P0744).

The TCC solenoid is checked functionally for stuck off faults by evaluating torque converter slip under steady state conditions when the torque converter is fully applied. If the slip exceeds the malfunction thresholds when the TCC is commanded on, a TCC malfunction is indicated (P0741).

The TCC solenoid is monitored functionally for stuck on faults (P2758) by monitoring for lack of clutch slip when the TCC is commanded off, but this code is non-MIL because while a stuck on TCC solenoid may cause driveability complaints and/or cause engine stalls it does not impact emissions or fuel economy.

### Electronic Pressure Control (EPC)

The EPC solenoid is a variable force solenoid that controls line pressure in the transmission. The EPC solenoid is monitored for open, short to ground or short to power faults by the "smart driver" that controls the solenoid. If a short to ground (low pressure) is detected, a high side switch will be opened. This switch removes power from all 7 VFSs, providing Park, Reverse, Neutral, and 5M (in all forward ranges) with maximum line pressure based on manual lever position. This solenoid is tested for open (P0960), short to ground (P0962), and short to power (P0963) malfunctions.

## Transmission Solenoid Power Control (TSPC)

6F140 PCM or TCM has an internal high side switch called TSPC that can be used to remove power from all 7 solenoids simultaneously. If the high side switch is opened, all 7 solenoids will be electrically off, providing Park, Reverse, Neutral, and 5M (in all forward ranges) with maximum line pressure based on manual lever position.

Due to current limitations TSPC is split into 2 pins / wires at the PCM / TCM. TSPC A provides power to SSA, SSC and SSE. TSPC B provides power to SSB, SSD, TCC and LPC. Each wire can be tested independently; P0657 sets for an issue with TSPC-A, P2669 sets for an issue with TSPC-B.

Although there are 2 pins and wires between the PCM / TCM and the transmission bulkhead connector the PCM / TCM contains only one TSPC internally – so the FMEM for either wire being failed is to open TSCP inside the PCM / TCM, which removes power from all 7 solenoids, providing P, R, N and 5<sup>th</sup> gear with open TCC and max line as FMEM for any TSPC faults.

ADLER (chip that controls all 7 solenoids) diagnostics:

The solenoids are controlled by an ADLER chip. The main micro sends commanded solenoid states to the ADLER, and receives back solenoid circuit fault information.

If communication with the ADLER is lost a P1636 fault code will be stored. If this failure is detected the states of the solenoids are unknown, so the control system will open the high side switch (removes power from all the solenoids), providing P, R, N and 5M with open TCC and max line pressure.

### **TRID Block**

The TRID block is a portion of flash memory that contains solenoid characterization data tailored to the specific transmission to improve pressure accuracy.

The TRID block is monitored for two failures:

- TRID block checksum error / incorrect version of the TRID (P163E)
- TRID block not programmed (P163F)

If the TRID block is unavailable FMEM action limits operation to P, R, N and 3<sup>rd</sup> gear based on manual lever position until the issue is correct.

## **Transmission Control Module (TCM – Diesel only)**

The TCM has the same module diagnostics as a PCM:

P0604 - Powertrain Control Module Random Access Memory (RAM) Error indicates the Random Access Memory read/write test failed.

P0605 - Powertrain Control Module Read Only Memory (ROM) Error indicates a Read Only Memory check sum test failed.

P0607 - Powertrain Control Module Performance indicates incorrect CPU instruction set operation, or excessive CPU resets.

P06B8 - Internal Control Module Non-Volatile Random Access Memory (NVRAM) Error indicates Permanent DTC check sum test failed

## CAN Communications Error

The TCM receives information from the ECM via the high speed CAN network. If the CAN link or network fails, the TCM no longer has torque or engine speed information available. The TCM will store a U0073 fault code and will illuminate the MIL immediately (missing engine speed) if the CAN Bus is off. The TCM will store a U0100 fault code and will illuminate the MIL immediately (missing engine speed) if it stops receiving CAN messages from the ECM. A U0401 fault codes will be stored if the ECM sends invalid/faulted information for the following CAN message items: engine torque, pedal position.

## TCM voltage

If the system voltage at the TCM is outside of the specified 9 to 16 volt range, a fault will be stored (P0882, P0883).

## On Board Diagnostic Executive

The On-Board Diagnostic (OBD) Executive is a portion of the PCM strategy that manages the diagnostic trouble codes and operating modes for all diagnostic tests. It is the "traffic cop" of the diagnostic system. The Diagnostic Executive performs the following functions:

- Stores freeze frame and "similar condition" data.
- Manages storage and erasure of Diagnostic Trouble Codes as well as MIL illumination.
- Controls and co-ordinates the execution of the On-Demand tests: Key On Engine Off (KOEO) and Key On Engine Running (KOER).
- Performs transitions between various states of the diagnostic and powertrain control system to minimize the effects on vehicle operation.
- Interfaces with the diagnostic test tools to provide diagnostic information (I/M readiness, various J1979 test modes) and responses to special diagnostic requests (J1979 Mode 08 and 09).
- Tracks and manages indication of the driving cycle which includes the time between two key on events that include an engine start and key off.

The diagnostic executive also controls several overall, global OBD entry conditions.

- The battery voltage must fall between 9.0 and 16.25 volts to initiate monitoring cycles.
- The engine must be started to initiate the engine started, engine running, and engine off monitoring cycles.
- The Diagnostic Executive suspends OBD monitoring when battery voltage falls below 11.0 volts.

The diagnostic executive controls the setting and clearing of pending and confirmed DTCs.

- A pending DTC and freeze frame data is stored after a fault is confirmed on the first monitoring cycle. If the fault recurs on the next driving cycle, a confirmed DTC is stored, freeze frame data is updated, and the MIL is illuminated. If confirmed fault free on the next driving cycle, the pending DTC and freeze frame data is erased on the next power-up.
- Pending DTCs will be displayed as long as the fault is present. Note that OBD-II regulations required a complete fault-free monitoring cycle to occur before erasing a pending DTC. In practice, this means that a pending DTC is erased on the next power-up after a fault-free monitoring cycle.
- After a confirmed DTC is stored and the MIL has been illuminated, three consecutive confirmed fault-free monitoring cycles must occur before the MIL can be extinguished on the next (fourth) power-up. After 40 engine warm-ups, the DTC and freeze frame data is erased.

The diagnostic executive controls the setting and clearing of permanent DTCs.

- A permanent DTC is stored when a confirmed DTC is stored, the MIL has been illuminated, and there are not yet six permanent DTCs stored.
- After a permanent DTC is stored, three consecutive confirmed fault-free monitoring cycles must occur before the permanent DTC can be erased.
- After a permanent DTC is stored, one confirmed fault-free monitoring cycle must occur, following a DTC reset request, before the permanent DTC can be erased. For 2010MY and beyond ISO 14229 programs

a driving cycle including the following criteria must also occur, following the DTC reset request, before a permanent DTC can be erased:

- Cumulative time since engine start is greater than or equal to 600 seconds;
  - Cumulative vehicle operation at or above 25 miles per hour occurs for greater than or equal to 300 seconds (medium-duty vehicles with diesel engines certified on an engine dynamometer may use cumulative operation at or above 15% calculated load in lieu of at or above 25 miles per hour for purposes of this criteria); and
  - Continuous vehicle operation at idle (i.e., accelerator pedal released by driver and vehicle speed less than or equal to one mile per hour) for greater than or equal to 30 seconds.
- A permanent DTC can not be erased by a KAM clear (battery disconnect). Additionally, its confirmed DTC counterpart will be restored after completion of the KAM reset (battery reconnect).

## Exponentially Weighted Moving Average

Exponentially Weighted Moving Averaging is a well-documented statistical data processing technique that is used to reduce the variability on an incoming stream of data. Use of EWMA does not affect the mean of the data; however, it does affect the distribution of the data. Use of EWMA serves to “filter out” data points that exhibit excessive and unusual variability and could otherwise erroneously light the MIL.

The simplified mathematical equation for EWMA implemented in software is as follows:

$$\text{New Average} = [\text{New data point} * \text{“filter constant”}] + [(1 - \text{“filter constant”}) * \text{Old Average}]$$

This equation produces an exponential response to a step-change in the input data. The “Filter Constant” determines the time constant of the response. A large filter constant (i.e. 0.90) means that 90% of the new data point is averaged in with 10% of the old average. This produces a very fast response to a step change. Conversely, a small filter constant (i.e. 0.10) means that only 10% of the new data point is averaged in with 90% of the old average. This produces a slower response to a step change.

When EWMA is applied to a monitor, the new data point is the result from the latest monitor evaluation. A new average is calculated each time the monitor is evaluated and stored in Keep Alive Memory (KAM). This normally occurs each driving cycle. The MIL is illuminated and a DTC is stored based on the New Average store in KAM.

In order to facilitate repair verification and DDV demonstration, 2 different filter constants are used. A “fast filter constant” is used after KAM is cleared or DTCs are erased and a “normal filter constant” is used for normal customer driving. The “fast filter” is used for 5 driving cycles after KAM is cleared/DTCs are erased, and then the “normal filter” is used. The “fast filter” allows for easy repair verification and monitor demonstration in 2 driving cycles, while the normal filter is used to allow up to 6 driving cycles, on average, to properly identify a malfunction and illuminate the MIL. This feature is called Fast Initial Response (FIR). The fast filter is always calibrated to 0.99 which means that the EWMA is effectively disabled because the new average is 99% of the new data point. Since the EWMA is effectively disabled, it takes two driving cycles to set the MIL. The first driving cycle with a fault will set a pending DTC; the second driving cycle will set a confirmed code and illuminate the MIL.

The other unique feature used with EWMA is called Step Change Logic (SCL). This logic detects an abrupt change from a no-fault condition to a fault condition. This is done by comparing the new data point to the EWMA old average. If the two points differ by more than a calibrated amount (i.e. the new data point is outside the normal distribution), it means that a catastrophic failure has occurred. The fast filter is then used in the same manner as for the FIR feature above. Since the EWMA is effectively disabled, it takes two driving cycles to set the MIL. The first driving cycle with a fault will set a pending DTC; the second driving cycle will set a confirmed code and illuminate the MIL. The SCL becomes active after the 4th “normal” monitoring cycle to give the EWMA a chance to stabilize.

During “normal” EWMA operation, a slower filter constant is used. The “normal filter” allows the MIL to be illuminated in 1 to 6 driving cycles. A confirmed code is set and the MIL is illuminated as soon as the EWMA crosses the malfunction threshold. There is no pending DTC because EWMA uses a 1-trip MIL.

In order to relate filter constants to driving cycles for MIL illumination, filter constants must be converted to time constants. The mathematical relationship is described below:

$$\text{Time constant} = [ ( 1 / \text{filter constant} ) - 1 ] * \text{evaluation period}$$

The evaluation period is a driving cycle. The time constant is the time it takes to achieve 68% of a step-change to an input. Two time constants achieve 95% of a step change input.

## Serial Data Link MIL Illumination

The OBD-II diagnostic communication messages utilize an industry standard 500 kbps CAN communication link.

The instrument cluster on some vehicles uses the same CAN data link to receive and display various types of information from the PCM. For example, the engine coolant temperature information displayed on the instrument cluster comes from the same ECT sensor used by the PCM for all its internal calculations.

These same vehicles use the CAN data link to illuminate the MIL rather than a circuit, hard-wired to the PCM. The PCM periodically sends the instrument cluster a message that tells it to turn on the MIL, turn off the MIL or blink the MIL. If the instrument cluster fails to receive a message within a 5-second timeout period, the instrument cluster itself illuminates the MIL. If communication is restored, the instrument cluster turns off the MIL after 5 seconds. Due to its limited capabilities, the instrument cluster does not generate or store Diagnostic Trouble Codes.

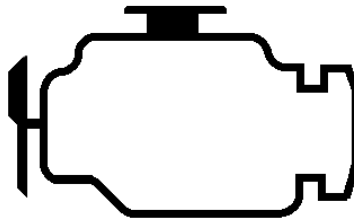

## Calculated Load Value

$$\text{LOAD\_PCT (PID \$04)} = \frac{\text{Current Calculated Torque}}{\text{Maximum Engine Torque at conditions}}$$

Where:

- Current Calculation of torque is derived from the injected quantity of torque producing fuel and engine speed.
- Maximum Engine Torque is derived from the maximum curve.

## I/M Readiness

The readiness function is implemented based on the SAE J1979/ISO 15031-5 format. Clearing codes using a scan tool results in the various I/M readiness bits being set to a “not-ready” condition. As each non-continuous monitor completes a full diagnostic check, the I/M readiness bit associated with that monitor is set to a “ready” condition. This may take one or two driving cycles based on whether malfunctions are detected or not. The readiness bit for comprehensive component monitoring is immediately considered complete since they are continuous monitors. The table below shows which monitors must complete for I/M readiness.

I/M Readiness bit	Controlling Monitor
Boost Pressure	P0234 P0299 P026A P132B P1249
CCM	Always Ready
EGR	P0401 P0402 P2457 P24A5
Exhaust Gas Sensors	P0139 C3994 P229F P06EB P229E
Fuel System	P0088 P0093 P0088 C2414 P02CC P02D0 P02D8 P02CE P02D6 P02D4 P02D2 P02DA
HC Catalyst	P0420
Misfire	P0301 P0303 P0307 P0302 P0306 P0305 P0304 P0308 P0300
NOx Catalyst	P20EE P249C
PM Catalyst	P244A P249F P2002 P2459

## **Power Take Off Mode**

A Power Take-Off (PTO) unit refers to an engine driven output provision for the purposes of powering auxiliary equipment (e.g., a dump-truck bed, aerial bucket, or tow-truck winch). The OBD-II regulations have historically accommodated PTO by requiring the software to set all I/M readiness bits to "not complete" when PTO was engaged and reset them to their previous state when PTO was disengaged.

The 2015 MY OBD-II regulations have changed the requirement for PTO mode. This is in reaction industry request to accommodate PTO while the vehicle is stationary (stationary PTO) or while the vehicle is moving (mobile PTO). In mobile PTO, some OBD monitors may not run or may run at reduced frequency. The changes to the OBD-II regulations accommodate vehicles being I/M tested while PTO is engaged.

For the 2015 MY, the OBD II system is required to track the cumulative engine runtime with PTO active and set all the OBD II I/M readiness bits to "not complete" if 750 minutes of cumulative engine runtime with PTO active has occurred and all OBD monitors have not yet completed. The PTO timer pauses whenever PTO changes from active to not active and resumes counting when PTO is re-activated. The PTO timer is reset to zero after all the affected monitors have completed. If an OBD monitor is completely disabled by PTO mode, the affected IUMPR numerator and denominator must also be disabled.

This new requirement provides a 750 minute allowance to run all OBD monitors before all the I/M readiness bits are set to "not complete" in order to better accommodate vehicles that have monitors that run with reduced frequency in PTO mode or have monitors that don't run at all.



## In-Use Monitor Performance Ratio

Manufacturers are required to implement software algorithms that track in-use performance for each of the following components: NMHC catalyst, NOx catalyst monitor, NOx adsorber monitor, PM filter monitor, exhaust gas sensor monitor, EGR/ VVT monitor, boost pressure monitor, and fuel system monitor. The numerator for each component or system tracks the number of times that all conditions necessary for a specific monitor to detect a malfunction have been encountered. The denominator for each component or system tracks the number of times that the vehicle has been operated in the specified conditions.

### Ignition Cycle Counter

Ignition cycle counter will increment after engine start  $\geq 1$  second

“Engine start” is defined as the point when the engine reaches a speed 150 rpm below the normal, warmed-up idle speed (as determined in the drive position for vehicles equipped with an automatic transmission).

### General Denominator Counter

General Denominator counter will increment if all the following conditions are met:

- Ambient Temperature  $\geq -7$  deg C (20 deg F)
- Barometric pressure  $\geq 752$  hPA (8,000 ft altitude)
- Time since engine start (or propulsion system active for hybrid)  $\Rightarrow 600$  s
- Time with vehicle speed greater or equal to than 40 kph (25 mph)  $\geq 300$  s
- Continuous vehicle operation at idle time (i.e., accelerator pedal released with vehicle speed  $\leq 1.6$  kph (1 mph))  $\geq 30$  s

The table below shows which monitors must complete to increment each IUMPR numerator.

IUMPR Counter Numerator	Controlling Monitor
NMHC Catalyst (500 Mile Denominator)	6.7L V8: P0420 3.2L I5: P0420
NOx Catalyst	6.7L V8: P20EE 3.2L I5: P207F
PM Filter	6.7L V8: P2459 P24A2 P24A0 P2457 P244A P2002 3.2L I5: P244A, P2459, P24A2
EG Sensor	6.7L V8: P0139 P2201 P2A01 P229F 3.2L I5: P2201, P229F, P2A01
EGR System Monitoring (No VVT on Ford Diesel Products)	6.7L V8: P0402 P2457 P24A5 3.2L I5: P0402, P2457
Boost Pressure	6.7L V8: P0299 P1247 P0234 P1249 P132B 3.2L I5: P132B, P026A, P0234, P1247
Fuel System	6.7L V8: P02DA P02CC P02D0 P02D8 P02CE P02D6 P02D4 P02D2 P0170 3.2L I5: P0170, P02CD, P02D1, P02CE, P02D3, P02D5

## Mode \$06 Results

Mode\$06 results are included for:

Mode\$06 Test Result	Controlling Monitor
HEGO	6.7L V8 & 3.2L I5: P2201 P0139 P2A01
Cat Bank 1	6.7L V8 & 3.2L I5: P0420
Diesel EGR	6.7L V8 & 3.2L I5: P0401 P0402 P2457 P24A5
Fuel System	6.7L V8: P02CD P02D1 P02D9 P02CF P0170 P02D7 P02D5 P02D3P02DB  3.2L I5: P0170, P02CD, P02D1, P02CE, P02D3, P02D5
Boost Pressure Control	6.7L V8: P026A P132B P0234 P0299 P1249 P00BC P00BD  3.2L I5: P132B P026A P0234 P1247
NOx Catalyst	6.7L V8: P20EE P207F  3.2L I5: P207F
Misfire	6.7L V8: P0308 P0301 P0303 P0307 P0302 P0306 P0305 P0304  3.2L I5: P0301, P0302, P0303, P0304, P0305
PM Catalyst	6.7L V8: P2459 P2002 P24A2  3.2L I5: P244A, P2459, P24A2